

INSTALLATION OPERATION AND SERVICE MANUAL MODULATING MICROFLAME SERIES



**GAS FIRED RESIDENTIAL AND COMMERCIAL COPPER TUBE
BOILERS**



FOR HYDRONIC HEATING

Non-Condensing Models; MFH060, 100, 150, 200, 250, 300, 400, 500, 600
Condensing Models; MFH062, 102, 152, 202, 252, 302, 402, 502, 602



HOT WATER SUPPLY

Non-Condensing Models; MFW060, 100, 150, 200, 250, 300, 400, 500, 600
Condensing Models; MFW062, 102, 152, 202, 252, 302, 402, 502, 602



WARNING: If the information in these instructions is not followed exactly, a fire or explosion may result causing property damage, personal injury or death

- Do not store or use gasoline or other flammable vapours and liquids in the vicinity of this or any other appliance.
- **WHAT TO DO IF YOU SMELL GAS**
 - Do not try to light any appliance,
 - Do not touch any electrical switch; do not use any phone in your building,
 - Immediately call your gas supplier from a neighbour's phone. Follow the gas supplier's instructions,
 - If you cannot reach your gas supplier, call the fire department.
- Qualified installer, service agency or the gas supplier must perform installation and service.

To the installer: After installation, these instructions must be given to the end user or left on or near the heater.
To the End User: This booklet contains important information about this heater. Retain for future reference.

CAMUS HYDRONICS LTD.

6226 Netherhart Road, Mississauga, Ontario, L5T 1B7

Table of Contents

1	GENERAL INFORMATION	1
2	BOILER LOCATION.....	2
3	PROVIDE AIR FOR COMBUSTION AND VENTILATION	3
4	ELECTRICAL WIRING.....	4
5	MODULATION SEQUENCE	4
6	GAS SUPPLY AND PIPING.....	5
7	VENTING.....	6
7.1	OUTDOOR VENTING	8
7.2	SIDEWALL VENTING.....	9
7.3	OUTDOOR AIR KIT.....	9
7.4	FILTER KIT	9
7.5	STANDARD VENTING	9
7.6	VENTING FOR CONDENSING APPLICATION.....	10
8	ACCESSORIES	11
8.1	WATER FLOW SWITCH (shipped loose)	11
8.2	LOW WATER CUTOFF (If Equipped).....	11
8.3	RELIEF VALVE (shipped loose)	11
9	FREEZE PROTECTION.....	12
10	WARNING REGARDING CHILLED WATER SYSTEMS.....	12
11	PIPING OF BOILER TO SYSTEM	13
12	PLACING BOILER IN OPERATION.....	14
13	IGNITION SYSTEM SAFETY SHUT-OFF DEVICE.....	14
14	LOW WATER TEMPERATURE SYSTEMS	15
15	INSTANTANEOUS WATER HEATER.....	16
16	CONDENSING HEAT RECOVERY MODULE (CHRM).....	16
17	INSTRUMENTATION AND CONTROLS.....	20
17.1	SAFETY CONTROLS.....	20
17.2	CONTROL PANEL	20
17.3	SETTING THE APPLIANCE TEMPERATURE CONTROLLER	21
17.4	MODES OF OPERATION	21
18	MICROFLAME CONTROL PANEL.....	28
18.1	GENERAL SYMBOL DESCRIPTION	29
18.2	MODE 1 & 2: SETPOINT OPERATION: VIEW DISPLAY	30
18.3	MODE 1 & 2: SETPOINT OPERATION: ADJUST DISPLAY	31
18.4	MODE 3: DEDICATED DOMESTIC HOT WATER OPERATION: VIEW DISPLAY.....	32
18.5	MODE 3: DEDICATED DOMESTIC HOT WATER OPERATION: ADJUST DISPLAY	33
18.6	MODE 4 & 5: OUTDOOR RESET OPERATION: VIEW DISPLAY	34
18.7	MODE 4 & 5: OUTDOOR RESET OPERATION: ADJUST DISPLAY	35
18.8	MODE 6 & 7: EXTERNAL TARGET TEMPERATURE INPUT OPERATION: VIEW DISPLAY.....	36
18.9	MODE 6 & 7: EXTERNAL TARGET TEMPERATURE INPUT OPERATION: ADJUST DISPLAY	37
18.10	MODE 8: EXTERNAL DRIVE OPEATION: VIEW DISPLAY	38
18.11	MODE 8: EXTERNAL DRIVE OPEATION: ADJUST DISPLAY	39
18.12	ERROR MESSAGES.....	39
19	PILOT AND MAIN BURNER FLAMES	41
19.1	MAIN BURNER	41
19.2	PILOT BURNER	44
20	OPERATION AND SERVICE.....	44
20.1	PRE-START CHECKLIST	44
20.2	START-UP	45

20.3	SERVICE.....	50
21	LIGHTING INSTRUCTIONS	50
22	TROUBLESHOOTING GUIDE	51
23	TYPICAL GAS TRAIN.....	52
24	ELECTRICAL DIAGRAMS.....	53
24.1	MF 60 - 300 INTERNAL WIRING CONNECTION DIAGRAM	54
24.2	MF 400 - 600 INTERNAL WIRING CONNECTION DIAGRAM	55
24.3	MF 60 – 1000 INTERNAL WIRING LADDER DIAGRAM	56
25	EXPLODED VIEW	57
26	MICOFLAME REPLACEMENT PARTS LIST	58
	WARRANTY.....	61

1 GENERAL INFORMATION

Camus Hydronics proudly introduces the Modulating MicoFlame series of water heaters / hydronic boilers. The Modulating MicoFlame is a fan assisted appliance based on a push through design which offers several venting options. Heat output is controlled by an adjustable ratio air/gas control valve. The Modulating MicoFlame Models are capable of modulating from 100% down to 35% of rated input. These gas-burning appliances are thoughtfully designed for easy operation and maintenance. We are confident that you will come to appreciate the benefits of our product.

The installation of this heater must conform to the requirements of the authority having jurisdiction or, in the absence of such requirements, to the latest or current as amended National Fuel Gas Code, ANSI Z223.1 or current CAN/CGA B149 Installation Codes. All electrical wiring must be done in accordance with the requirements of the authority having jurisdiction or, in the absence of such requirements, with the National Electrical Code, ANSI/NFPA 70 or the Canadian Electrical Code Part I, CSA C22.1 Electrical Code.

Vent installations must be in accordance with Part 7, Venting of Equipment, of the latest or current as amended National Fuel Gas Code, ANSI Z223.1, or Section 7, Venting Systems and Air Supply for Appliances, of the current CAN/CGA B149, Installation Codes and applicable provisions of the local building codes.

When required by the authority having jurisdiction, the installation must conform to the Standard for Controls and Safety Devices for Automatically Fired Boilers, ANSI/ASME CSD-1.

The qualified installer shall instruct the end user in the safe and correct operation of this appliance and shall ensure that the heater is in safe working order prior to leaving the job site.

WARRANTY:

Factory warranty shall apply only when the boiler is installed in accordance with local plumbing and building codes, ordinances and regulations, the printed instructions provided with it and good industry practices.

Excessive water hardness causing a lime build-up in the copper coils or tubes is not a fault of the boiler and is not covered by warranty. Consult the factory for recommendations for use in hard water areas.

Using or storing corrosive chemicals in the vicinity of this boiler can rapidly attack the copper tubes and coils and voids warranty.

The primary heat exchanger of this boiler is intended to operate under non-condensing conditions. Inlet temperatures must be maintained at 130°F or higher. Warranty is void if the primary heat exchanger is allowed to operate in condensing mode.

Damage caused by freezing or dry firing voids warranty.

This boiler is not to be used for temporary heating of buildings under construction.

2 BOILER LOCATION

Install this boiler in a clean, dry location with adequate air supply and close to a good vent connection. Do not locate this boiler in an area where it will be subject to freezing.

The boiler is suitable for installation on combustible flooring and should be located close to a floor drain in an area where leakage from the boiler or connections will not result in damage to the adjacent area or to lower floors in the structure. If necessary a suitable drain pan should be installed under the boiler.

If the boiler is installed above the level of the building's radiation system, a low water cutoff device must be installed in the boiler outlet at the time of installation. Some local codes require the installation of a low water cutoff on all systems.

Locate the boiler so as to provide adequate clearance for inspection and service all around the unit. It is recommended that 24" be provided for the top and sides and 48" for the front. This boiler is suitable for alcove installation with minimum clearances to combustibles as follows:

Table 1: Clearance to Combustibles

TOP:	12"
SIDES:	12"
REAR:	12"
VENT:	6"
FLOOR:	0"

For boiler's dimensions see Figure 1 and Table 2

Figure 1: Appliance Dimensions

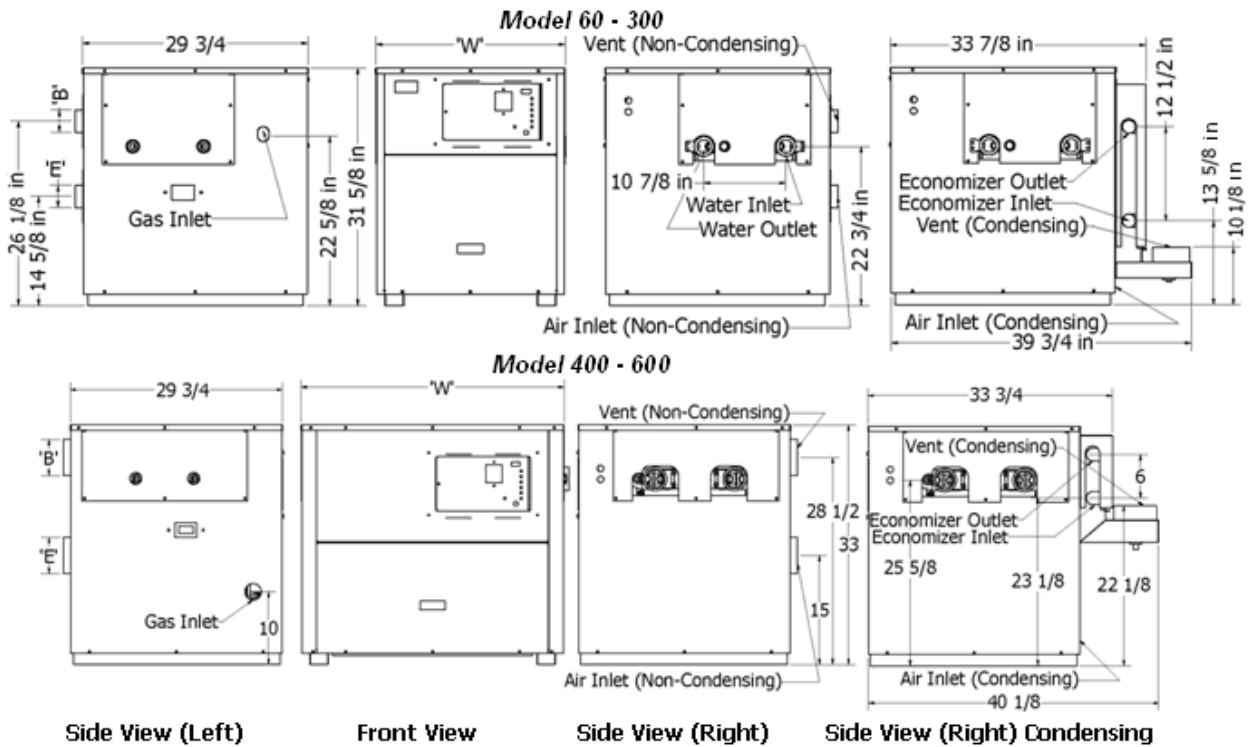

Table 2: Appliance Dimensions, (inches)

Model	'W'	Water Connection	Gas Connection	B' Dia. Venting			E' Dia.
				Outdoor	Sidewall or Condensing	Standard	Air Inlet
MFNH060	18 3/4	1 1/2	1/2	3	3	3	3
MFNH100	18 3/4	1 1/2	1/2	3	3	4	3
MFNH150	18 3/4	1 1/2	1/2	3	3	4	3
MFNH200	18 3/4	1 1/2	3/4	4	4	5	4
MFNH250	25	1 1/2	3/4	4	4	5	4
MFNH300	25	1 1/2	3/4	5	5	6	5
MFNH400	31 1/2	2	1	5	5	6	5
MFNH500	31 1/2	2	1	6	6	7	6
MFNH600	36 1/2	2	1	6	6	7	6

3 PROVIDE AIR FOR COMBUSTION AND VENTILATION

Provisions for combustion and ventilation air must be in accordance with:

- Section 5.3. Air for combustion and Ventilation, of the latest or current as amended National Fuel Gas Code, ANSI Z223.1, or;
- Sections 7.2, 7.3 or 7.4 of CAN/CGA B149 Installation Codes, and;
- Applicable provisions of the local building codes.

The operation of exhaust fans, compressors, air handling units etc. can rob air from the room, creating a negative pressure condition leading to reversal of the natural draft action of the venting system. Under these circumstances an engineered air supply is necessary.

If the heater is to be installed near a corrosive or potentially corrosive air supply, the heater must be isolated from it and outside air should be supplied as per code.

Potentially corrosive atmospheres will result from exposure to permanent wave solution, chlorinated waxes and cleaners, chlorine, water softening chemicals, carbon tetrachloride, halogen based refrigerants, Freon cleaning solvents, hydrochloric acid, cements and glues, masonry washing materials, antistatic fabric softeners, dry cleaning solvents, degreasing liquids, printing inks, paint removers, etc.

4 ELECTRICAL WIRING

All electrical wiring to the boiler must be electrically bonded to ground in accordance with the requirements of the authority having jurisdiction or, in the absence of such requirements, with the National Electrical Code, ANSI/NFPA 70 or the Canadian Electrical Code Part I, CSA C22.1, Electrical Code.

Provide disconnecting means of sufficient rating within sight of the boiler. These heaters require an 115V, 60Hz supply. Depending on the pump used, a 15-amp breaker is usually sufficient.

Electrical connections must be made so that the circulator will operate before the gas valve can open. At no time may the control system allow the burner to fire without water flowing in the system.

Use minimum 18-gauge conductor for 24-volt field wiring to boiler. Splicing of wires is not recommended. Use sealed tight conduit suitable for outdoor use for outdoor installations. Use terminal strip provided inside control panel for low water cut-off and remote controller. Refer to wiring diagram provided with boiler.

5 MODULATION SEQUENCE

Models 60 through 300 are supplied with 2 fans. The modulating fan is connected to the burner box and the single speed fan is used to provide combustion and cooling air to the space below the combustion chamber. Models 400 through 600 are supplied with only one modulating fan which pressurizes the space below the combustion chamber and feeds air to the venturi connected to the air/gas mix tube.

Before the appliance can light off, the air proving switch must be closed and the pilot must be lit. The blocked flue switch is normally closed and opens only under blocked air or blocked flue conditions. All models are supplied with a single burner.

Each MicoFlame is supplied with the appropriate wiring diagram showing the sequence provided as well as any special controls or options requested.

When converting multiple MicoFlame appliances to an external sequencing control each modulating heater can be regarded as one stage. In this way the sequencer will lead/lag or rotate the boilers properly. One option (Mode 8 on the BTC 1) allows the remote controller to initiate and modulate the boiler with a single 0-10V analog signal. Refer to Table 7 for details.

Pre-purge

BTC 1 Modulation control activates the pre-purge cycle for 20 seconds before trial for ignition.

Ignition Trial

On proof of air flow, the air proving switch closes and energizes the ignition module. The module first initiates a self check and then starts the pilot ignition sequence. The modulating sequence begins with the modulating fan ramping down to ignition speed. The safety shutoff valve opens, which allows gas to flow to the pilot burner. At the same time, the electronic spark generator in the module produces 10,000 Volt spark pulse output. The voltage generates a spark at the igniter that ignites the pilot. If the pilot does not light, or the pilot flame current is not at least, on average, 1.5 μ A and steady, the module will not energize the combination valve and the main burner will not light. The ignition module provides 100% gas shutoff, followed by retry for ignition. If required (e.g. CSD-1) a module with lockout feature can be provided.

Main Burner

When the pilot flame is established, a flame rectification circuit is completed between the sensor and the burner ground. The flame sensing circuit in the ignition module detects the flame current, shuts off the spark generator and energizes the combination control which is a one to one air/gas ratio control valve.

As the modulating fan ramps up, gas input is adjusted accordingly to match the airflow. When the call for heat ends, the valve is de-energized, and the fan modulates off.

Normal Operation

Modulation is controlled from the Boiler Temperature Controller. The modulating fan is equipped with an electrically commutated DC motor which responds to a PWM signal.

The control provided with the Modulating MicoFlame allows remote control with an analog signal of 4-20mA or 2-10VDC.

Demand Satisfied

The BTC 1 senses that the boiler target temperature was reached and de-energizes the stage contact.

Control Alarms

High limit or low water flow will de-energize all gas valves, and the blower. Condition indicators are visible on the control panel. Each burner/blower set is provided with its own air pressure switch. If a low air pressure condition is present, power will not be supplied to the ignition module. The blower will remain on and the air indicator will remain on for as long as there is a call for heat. If the safety proving sequence does not proceed to completion, the first safety light to remain off will indicate the cause of the problem. All other lights below the problem indicator light will also remain off.

6 GAS SUPPLY AND PIPING

This boiler is intended to operate at inlet gas pressures not exceeding ½ PSI (14" W.C.). If higher pressures are present, consult the gas company for correction.

When pressure testing the gas supply piping at pressures above ½ PSI, the boiler and its individual gas shut-off valve must be disconnected from the supply piping.

Provide a trap (drip leg) as close to the heater as possible.

Install a ground joint union and manual shut-off valve in the gas line near the heater to allow easy removal of the gas control assembly.

Provide gas pressures at inlet to boiler gas train as follows:

Table 3: Gas Pressures to Inlet to Appliance

	PROPANE	NATURAL GAS
Minimum Running (inches W.C.)	10	4
Maximum Lockup (inches W.C.)	11	14

The gas supply line must be of adequate size to prevent undue pressure drop and must never be smaller than the size of the connection on the heater. Sizing based on Table 4 is recommended.

Before operating the boiler, the complete gas train and all connections must be tested using soap solution.

Table 4: Gas pipe size for distance from natural gas meter or propane second stage regulator

DISTANCE FROM NATURAL GAS METER OR PROPANE SECOND STAGE REGULATOR						
Input Btu/Hr	0-100 FT		100-200 FT.		200-300 FT.	
	NAT.	L.P.	NAT.	L.P.	NAT.	L.P.
60,000	3/4"	1/2"	3/4"	1/2"	1"	3/4"
100,000	3/4"	1/2"	1"	3/4"	1"	3/4"
150,000	1"	3/4"	1 1/4"	1"	1 1/4"	1"
200,000	1"	3/4"	1 1/4"	1"	1 1/4"	1"
250,000	1 1/4"	1"	1 1/4"	1"	1 1/2"	1 1/4"
300,000	1 1/4"	1"	1 1/2"	1 1/4"	1 1/2"	1 1/4"
400,000	1 1/4"	1"	1 1/2"	1 1/4"	2"	1 1/2"
500,000	1 1/2"	1 1/4"	2"	1 1/2"	2"	1 1/2"
600,000	1 1/2"	1 1/4"	2"	1 1/2"	2"	1 1/2"

7 VENTING

Boilers for outdoor installation are intended to vent using a listed vent cap.

For indoor installations venting must be in accordance with Part 7, Venting of Equipment, of the latest or current as amended National Fuel Gas Code, ANSI Z223.1, or Section 7, Venting of Equipment and Air Supply for Appliances, of the CAN/CGA B149, Installation Codes, and applicable provisions of the local building codes.

Vent connectors serving appliances vented by natural draft shall not be connected into any portion of mechanical draft systems operating under positive pressure.

Horizontal runs of vent pipe shall be securely supported (approximately every 4 feet) to prevent sagging and maintain a minimum upward slope of 1/4" per foot from the boiler to the vent terminal.

When an existing boiler is removed from a common venting system, the common venting system is likely to be too large for proper venting of the appliances remaining connected to it. At the time of removal of an existing boiler, the following steps must be followed with each appliance remaining connected to the common venting system placed in operation, while the other appliances remaining connected to the common venting system are not in operation.

- a) Seal any unused openings in the common venting system.
- b) Visually inspect the venting system for proper size and horizontal pitch and determine that there is no blockage, restriction, leakage, corrosion or other deficiency, which could cause an unsafe condition.
- c) Insofar as is practical, close all building doors and windows and all doors between the space in which the appliances remaining connected to the common venting system are located and other spaces of the building. Turn on the clothes dryers and any appliances not connected to the common venting system. Turn on any exhaust fans, such as range hoods and bathroom exhausts, so they will operate at maximum speed, do not operate a summer exhaust fan. Close fireplace dampers.
- d) Place in operation the appliance being inspected. Follow the lighting instructions. Adjust thermostat so that appliance operates continuously.
- e) Test for spillage at the draft hood relief opening after 5 minutes of main burner operation. Use the flame of a match or candle or smoke from a cigarette.

- f) After it has been determined that each appliance remaining connected to the common venting system properly vents when tested as outlined above, return doors, windows, exhaust fans, fireplace dampers and any other gas-burning appliance to their previous condition of use.
- g) Any improper operation of the common venting system must be corrected so that the installation conforms to the National Fuel Gas Code, ANSI Z223.1 or CAN/CGA B149, Installation Codes. When resizing any portion of the common venting system, the common venting system should be resized to approach the minimum size as determined using the appropriate tables in Part 11 of the latest or current as amended National Fuel Gas Code, ANSI Z223, 1 or CAN/CGA B149, Installation Codes.

Heat exchanger surfaces and vent piping should be checked every six months for deterioration and carbon deposits. Remove all soot or other obstructions from the chimney and flue, which might impede draft action. Replace any damaged or deteriorated parts of the venting system.

A qualified service technician should follow this procedure when inspecting and cleaning the heat exchanger and vent pipe.

1. Turn off electrical power and close main manual gas shut-off and allow boiler to cool down
2. Remove the vent pipe running to chimney. Remove top outer panel and flue collector access panel. Check heat exchanger, vent and chimney for obstruction and clean as necessary.
3. Remove burner from boiler and vacuum the heat exchanger. If heat exchanger is excessively dirty it may be necessary to remove it from the boiler and wash it down with proper detergent cleaner. Be aware that the combustion chamber base is insulated with ¼" thick ceramic paper. If this material is damaged or displaced it must be replaced before starting up the boiler.
4. Reinstall parts removed in steps 2 and 3. Be sure that vent pipe has proper pitch and is properly sealed. Repair or replace any gaskets, which may have been damaged in steps 2 and 3.
5. **CAUTION:** When replacing the burner be careful to fully engage the back of the burner box into the retaining slot in the combustion chamber base. Failure to properly locate the burner will result in erratic flame operation with the possibility of delayed ignition on light off.
6. Restore electrical power and gas supply to boiler.
7. Place boiler in operation using lighting instructions provided.
8. While the boiler is operating, check for flue gas leaks and proper vent operation. Seal any flue gas leaks using appropriate gasket or sealing material. Carefully examine the flue collector access panel and heat exchanger ends.

The MicoFlame is a category 1, 85% efficient when supplied as a non-condensing appliance. When supplied with the optional condensing cartridge, the MicoFlame is 95% efficient and is considered to be a category II or IV appliance. Three venting options are available for this boiler. See Figure 2 for details. (Please refer to Table 2 for vent dimensions)

Figure 2: Venting Arrangement

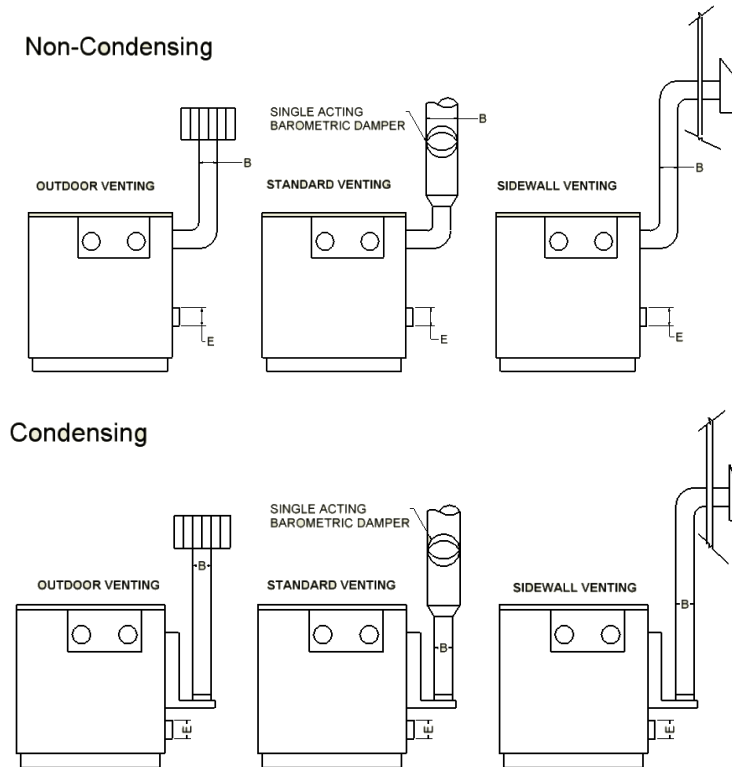

7.1 OUTDOOR VENTING

When fitted with the factory supplied rain shield and UL approved vent cap, the MicoFlame is self-venting. The following applies to outdoor installations:

1. Use only factory supplied rain shields.
2. Periodically check to ensure that air intake and vent cap are not obstructed.
3. Locate boiler at least 3 feet away from any overhang.
4. Locate boiler at least ten feet from building air intake.
5. Avoid installation in areas where runoff from adjacent building can spill onto boiler.

7.2 *SIDEWALL VENTING*

When fitted with the factory supplied vent terminal, the MicoFlame can vent up to 50 equivalent feet. Elbows can range from 5 to 9 feet in equivalent length depending on centreline radius. See Table 2 for vent sizes.

Boilers may be installed with either a horizontal sidewall vent or vertical roof top terminal. Terminals differ with each application. Horizontal lengths over 5 feet must be installed using corrosion resistant stainless steel. Use single wall vent and seal all joints or use pressure rated double wall vent.

Refer to local codes for proper installation and location of vent terminals.

When using sidewall vent, all vent connector seams and joints must be sealed with pressure sensitive aluminium tape or silicone sealant as specified by the vent manufacturer. Aluminium tape must meet the provisions of SMACNA AFTS-100-73 Standard.

When venting through unheated spaces with single wall vent, insulation should be wrapped around the vent pipe to prevent flue gas condensation inside the vent.

Periodically check to ensure that the vent terminal is unobstructed.

7.3 *OUTDOOR AIR KIT*

When fitted with the factory supplied air inlet ring and air intake terminal, the MicoFlame can draw outdoor air over an equivalent length of 50 feet. See Table 2 for vent sizes.

Boilers may be installed with either a horizontal sidewall vent or vertical roof top terminal. Terminals differ with each application.

The following applies to outdoor air installations:

1. Use only factory supplied air intake terminal.
2. Periodically check to ensure that air intake is not obstructed.
3. Refer to local codes for proper installation and location of vent terminals. Vertical vent terminal must be at least 3 feet above the highest point where it is located above the roof of a building and at least two feet higher than any part of the building within a horizontal distance of ten feet
4. Locate the air intake five feet away from the vent discharge. For sidewall venting locate the air intake below the vent outlet if possible.

7.4 *FILTER KIT*

A collar sized as per Table 2 is the standard air inlet configuration for the MicoFlame. A filter kit is available. The filter is washable and accounts for an additional pressure loss of less than 0.05" W.C. Highly recommended for dusty environments.

The filter kit can also be provided when using the outdoor air kit.

7.5 *STANDARD VENTING*

The non-condensing 85% efficient MicoFlame is a category 1 appliance and is approved for venting into a common standard chimney. If chimney height is much greater than 30 feet or if drafts are in excess of negative 0.05" W.C., it will be necessary to provide a single acting barometric damper directly above the vent collar. This damper will ensure smooth light off and minimize standby loss through the boiler. Be sure to position the damper at least 6 "away from the wall of the vent connector.

7.6 VENTING FOR CONDENSING APPLICATION

When supplied with the optional condensing cartridge, the MicoFlame is 95% efficient (category II or IV appliance) which requires the use of a special venting system fabricated from AL29-4C material. Only venting components listed by a nationally recognized testing agency may be used.

This appliance may be installed with conventional, sidewall or vertical venting. Conventional vented appliances operate with negative pressure in the vent pipe and require a special vent adapter to increase the flue outlet diameter. Sidewall and vertically vented appliances operate with positive pressure in the vent pipe and may be directly connected to the flue outlet without the use of an increaser.

Consult the vent pipe manufacturer's instructions for minimum clearances to combustible material for vent components. In the absence of instructions, the minimum clearance to combustible material is six inches.

Consult vent pipe manufacturer's instructions for proper method of sealing vent pipe sections and fittings. In the absence of instructions, make sure that pipe and fittings are clean by swabbing with alcohol. Use Dow Corning 736 or 732 RTV, Polybar # 500 RTV or Sil-bond 4500 or 6500 to seal vent pipe. Do not use other sealants or adhesives except as expressly permitted by vent manufacturer's instructions.

Consult vent pipe manufacturer's instructions for vent system assembly. Follow vent pipe manufacturer's instructions if those instructions differ from this section.

Conventional Venting

Multiple condensing appliances may be vented into a common chimney. The chimney must be lined with AL29-4C and a single acting barometric damper must be provided for each appliance.

A qualified professional using a proven vent-sizing program with input of accurate operating parameters must properly calculate sizing of the venting system. In applications where flue gas temperatures are lower than can support a Category II with conventional negative draft, it will be determined at the venting design stage that a positive pressure will be developed in the vent. It will then be necessary to either provide separate vents as for Category IV, or to provide an extractor at the chimney outlet in order to maintain a negative draft in the chimney and allow common venting.

Approval of the installation will be at the discretion of authorities having jurisdiction.

The chimney must be protected from down drafts, rain and debris by using a listed chimney cap.

Sidewall and Vertical Venting

The maximum vent length is 50 equivalent feet. Vent pipe may be run through a vertical or horizontal chase provided that minimum clearances to combustibles are maintained.

The vent termination location is restricted as follows:

Minimum 12 inches above grade plus normally expected snow accumulation. Or 7 feet above grade if located adjacent to public walkways. Do not install over public walkway where local experience indicates condensation or vapor from the appliance creates a nuisance or hazard. Minimum 3 feet above any forced air inlet located within 10 feet of vent termination. Minimum 4 feet below, 4 feet horizontally or above any door window or gravity air inlet. Minimum 4 feet horizontally from electric meters, gas meters, regulators and relief valves. Use appropriately designed thimbles when passing through combustible walls or roofs. Install fire stops where vent passes through floors, ceilings or framed walls. The fire stop must close the opening between the vent pipe and the structure. Locate vent terminal above combustion air intake terminal (if used) and no closer than 2 feet vertically or horizontally. Vertical venting requires flashing and a storm collar to prevent moisture from entering the structure. Vertical vent termination must be at least 2 feet plus the expected snow accumulation above the roof penetration height.

8 ACCESSORIES

8.1 WATER FLOW SWITCH (*shipped loose*)

A water flow switch is shipped loose and is to be installed in the outlet piping on all heating boilers and hot water supply boilers. The flow switch is wired in series with the 24VAC safety control circuit. A diagnostic light will be indicated on the control display on a low flow condition.

8.2 LOW WATER CUTOFF (*If Equipped*)

If this boiler is installed above radiation level, a low water cut-off device must be installed at the time of boiler installation. Some local codes require the installation of a low water cut-off on all systems. Electronic low water cut-offs are available as a factory supplied option on all models. Low water cut-offs should be tested every six months. The normally open switch contact of the low water cutoff is to be wired in series with the flow switch. A diagnostic light will be indicated on the control display on a low flow condition. Caution: remove jumper when connecting to 24 VAC circuit.

Figure 3: Low Water Cutoff Electrical Connections

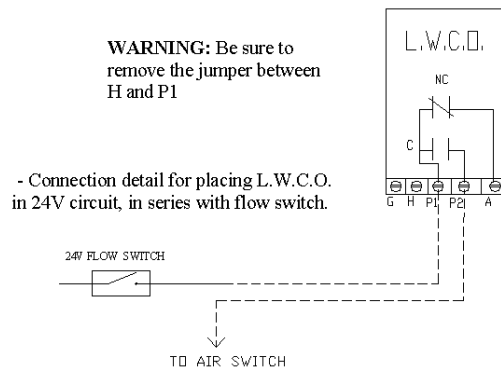

8.3 RELIEF VALVE (*shipped loose*)

This appliance is supplied with a relief valve sized in accordance with ASME Boiler and Pressure Vessel Code, Section IV (“Heating Boilers”). The relief valve is to be installed in the vertical position and mounted in the hot water outlet. No valve is to be placed between the relief valve, and the appliance. To prevent water damage, the discharge from the relief valve shall be piped to a suitable floor drain for disposal when relief occurs. No reducing couplings or other restrictions shall be installed in the discharge line. The discharge line shall allow complete drainage of the valve and line. Relief valves should be manually operated at least once a year.

9 FREEZE PROTECTION

- Appliance installations are not recommended outdoors in areas where danger of freezing exists unless precautions are taken. Maintaining a mixture of 50% water and 50% propylene glycol is the preferred method of freeze protection in hydronic systems. This mixture will protect the appliance to approximately -35°F (-37°C). To maintain the same temperature rise across the appliance increase the GPM flow by 15% and the head loss by 20%.

The following example demonstrates the procedure to follow for calculating the revised head for the heat exchanger when using a water / glycol mixture.

- Given for example that Camus is showing a heat exchanger flow and head loss of 100 gpm @ 10 feet
- Increasing the flow by 15% now results in a head loss of 13 feet at 115 gpm (from B&G system syzer). At this increased flow Camus now recommends to increase the head loss by 20%.
- The requirement for the heat exchanger with water / glycol mixture will now be 115 gpm @ 15.6 feet. (ie. $1.2 \times 13\text{ft.} = 15.6\text{ ft.}$)
- A similar procedure must be followed to calculate the additional head loss in pipe and fittings in order to arrive at the proper pump selection.
- For Outdoor installations a snow screen should be installed to prevent snow and ice accumulation around the appliance. Regular inspections should be made to ensure that air intake and vent are free of snow and ice. Always consider the use of a shelter such as a garden shed in lieu of direct exposure of the appliance to the elements. The additional protection afforded by the shelter will help to minimize nuisance problems with electrical connections and will allow easier servicing of the appliance under severe weather conditions.

10 WARNING REGARDING CHILLED WATER SYSTEMS

When a boiler is connected to an air conditioning system where the same water is used for heating and cooling, the chiller must be piped in parallel with the boiler. Appropriate flow control valves; manual or motorized must be provided to prevent the chilled water from entering the boiler. (See Figure 4)

Figure 4: Typical Chilled Water System

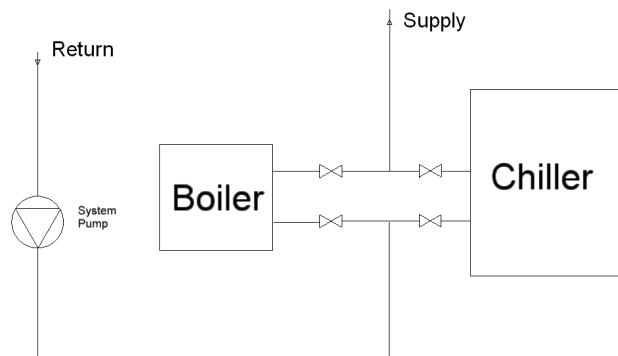

When a boiler is connected to heating coils located in air handling units (where they may be exposed to refrigerated air circulation), the boiler piping system shall be equipped with a flow control valve or other automatic means to prevent gravity circulation of chilled water through the boiler. Chilled water in the boiler will create condensate on the boiler tubes, which will collect in the combustion chamber causing corrosion.

11 PIPING OF BOILER TO SYSTEM

Check all applicable local heating, plumbing and building safety codes before proceeding.

Be sure to provide unions and gate valves at inlet and outlet to boiler so that it can be easily isolated for service.

This boiler is of a low mass design, which provides for instant heat transfer. Special attention to water low rates will ensure that temperature rise does not exceed 35°F (19.4°C). The following Table is provided as a guide.

For application in areas known to have hard water conditions, contact factory for recommendations.

Table 5: Flow and Pressure Drop at a Given Temperature Rise

Head Loss and Flow Vs Temperature Rise

Model	10 °F		20 °F		30 °F	
	USGPM	ΔP ft.	USGPM	ΔP ft.	USGPM	ΔP ft.
60	10.2	0.03	5.1	0.01	3.4	0.005
100	17.0	0.07	8.5	0.02	5.7	0.010
150	25.5	0.20	12.8	0.04	8.5	0.030
200	34.0	0.40	17.0	0.08	11.3	0.050
250	42.5	0.65	21.3	0.16	14.2	0.100
300	51.0	1.50	25.5	0.49	17.0	0.190
400	68.0	2.00	34.0	0.55	22.7	0.260
500	85.0	3.00	42.5	0.76	28.3	0.390
600	102.0	4.30	51.0	1.15	34.0	0.550

Figure 5: Typical Boiler Piping to System

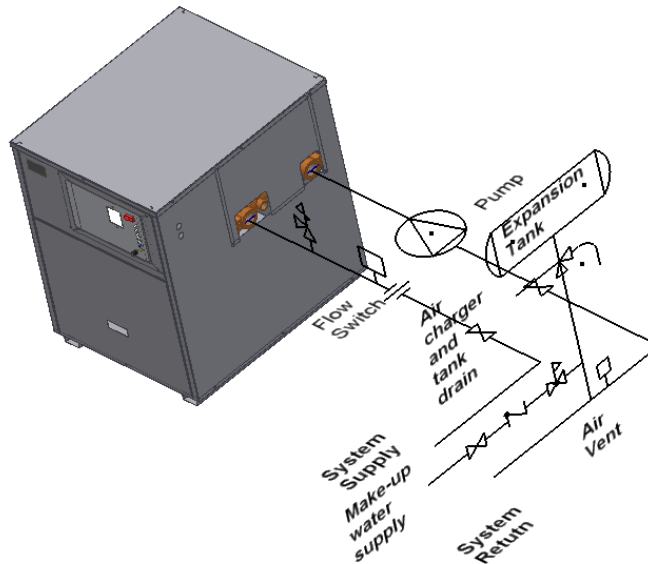

If the boiler is installed above radiation level, it must be provided with a low water cutoff device at the time of boiler installation. (Available from factory)

To eliminate trapped air, install venting devices at high points in the system as well as in the piping on the suction of the pump and in the piping on the discharge of the boiler.

Suitable pipe hangers must support the weight of all water and gas piping or floor stands.

Do not allow the boiler to run with inlet water temperature below 130°F.

The boiler must be installed so that the gas ignition system components are protected from water (dripping, spraying, rain, etc.) During appliance operation and service (circulator replacement, control replacement, etc.)

12 PLACING BOILER IN OPERATION

The MicoFlame boiler should be installed and started up by qualified personnel.

With the boiler off, open makeup water valve and allow system to fill slowly. Adjust the pressure regulator to provide at least 15 PSIG in the system when cold.

With all air vents open, run system circulating pump for a minimum of 30 minutes with the boiler off.

Open all strainers in the circulating system and check for debris.

Check liquid level in expansion tank. With system full of water at 15 PSIG, the level of water in the expansion tank should not exceed $\frac{1}{4}$ of the total volume with the balance filled with air.

Start up boiler following instructions provided. Operate entire system including pumps and radiation for at least 1 hour.

Check water level in expansion tank. If level exceeds $\frac{1}{2}$ of tank volume, air is still trapped in system. Shut down boiler and continue to run pumps.

Within 3 days of start up, recheck all air vents and expansion tank as described above.

13 IGNITION SYSTEM SAFETY SHUT-OFF DEVICE

After initial fill while the main burner is firing, shut off gas to the pilot and clock the time taken for the main gas valve to shut down. If the safety control is functioning properly, power to the gas valve will be shut off within 4 seconds of the pilot gas being shut off. If shut down takes longer, ignition control or gas valve may be defective.

14 LOW WATER TEMPERATURE SYSTEMS

In applications where the heating system requires supply water temperatures below 130°F (55 °C), a bypass line must be installed upstream of the boiler pump so that outlet water can be re-circulated to raise the inlet temp to a minimum of 130°F (55 °C). Balancing valves, preferably globe valves are used to adjust flow (See Figure 6). Alternatively, a thermostatic mixing valve may be supplied (available as a factory option)

Figure 6: Low Water Temperature System

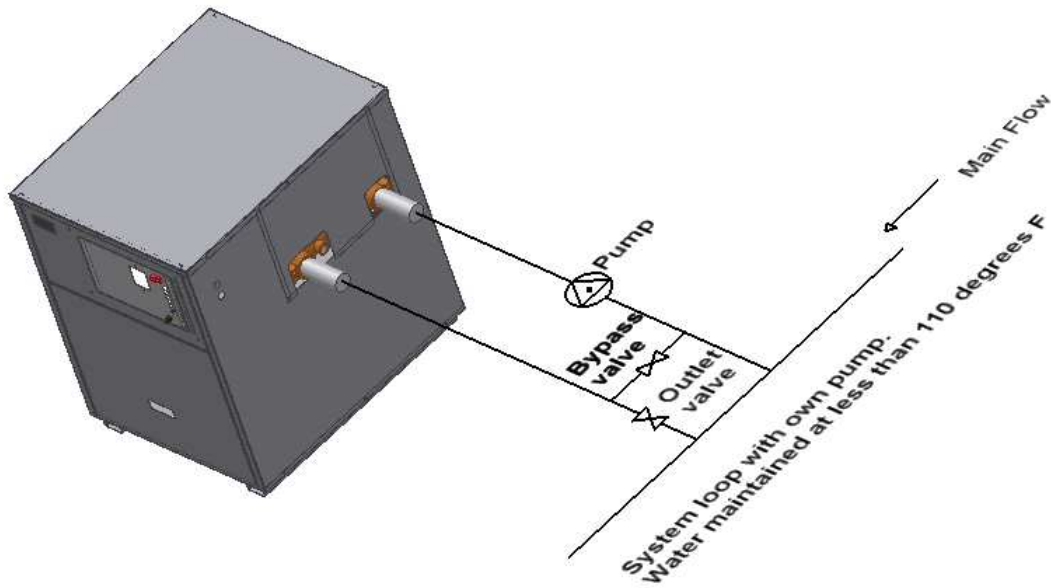

- Adjustment procedure.
 - a. Fully open bypass and outlet valves.
 - b. With boiler running, read inlet temperature after 15 minutes.
 - c. If the inlet temperature is less than 130°F (55 °C) slowly close outlet valve until the inlet temperature climbs to 130°F (55 °C)
 - d. If the inlet temperature is greater than 130°F (55°C) but not greater than 140°F (60 °C) no further adjustment is required.
 - e. Check the inlet temperature after 5 minutes and make final adjustments.

15 INSTANTANEOUS WATER HEATER

An instantaneous water heater is designed to deliver hot water without the use of a storage tank. It is suitable for applications with variable load such as restaurants, condominiums, apartments and motels. (See Figure 7) Call factory for recommendations.

Figure 7: Instantaneous Water Heater Suggested Piping

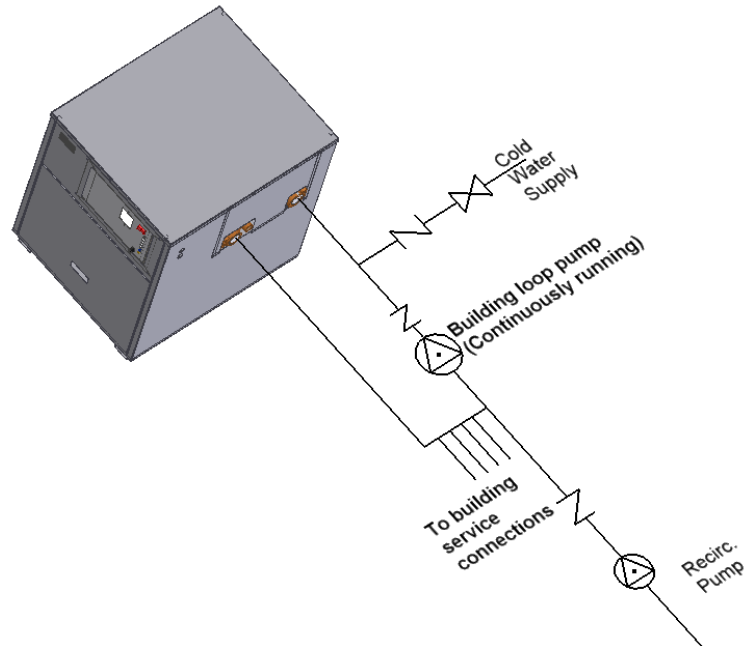

16 CONDENSING HEAT RECOVERY MODULE (CHRM)

The MicoFlame All Stainless Steel CHRM is mounted in a stainless steel chamber at the rear of the appliance. The CHRM is constructed from all stainless steel headers and special multiple horizontal stainless tubes. This CHRM is designed to maximize heat transfer efficiency by fully condensing flue products and is suitable to resist the low pH of condensate.

The CHRM must be supplied with adequate water flow at all times during operation. Do not operate the appliance with the CHRM piped out or isolated.

The CHRM is mounted in the discharge of the flue products from the primary heat exchanger. This allows additional heat to be absorbed from the flue products exhausted from the combustion process. If isolation valves are provided on the CHRM, the provision of a relief valve at the outlet of the CHRM is recommended. This valve is to be sized at minimum for 10% of the input of the appliance and is to be piped to drain.

When cold water supply with temperatures less than 130°F (55°C) passes through the CHRM it will cool the flue products below dew point resulting in the formation of condensation. Furthermore, the volumetric flow rate of the flue gases will be reduced.

The appliance CHRM loop may be used in condensing mode for a variety of application including domestic hot water and hydronic space heating. Recommended piping arrangement is shown in Figure 8. Maximum capacity through the CHRM is summarized in Table 6; flows in excess of 60 GPM must be bypassed.

Figure 8: Typical Condensing System

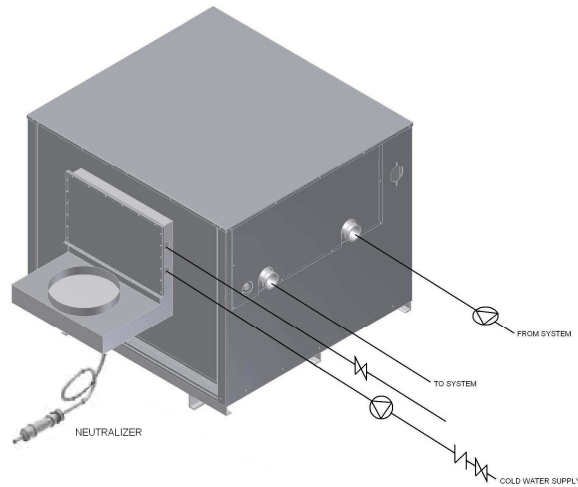

Condensate from the MicoFlame must be treated before being discharged to drain. pH level of the condensate is to be checked regularly and the neutralizing medium is to be replaced as required. A neutralizing cartridge is available from the factory. The condensing MicoFlame must be vented using only special venting type AL29-4C stainless steel or equivalent, please follow instructions detailed below.

When supplied with the CHRm, the MicoFlame is 95% efficient (category II or IV appliance) which requires the use of a special venting system fabricated from AL29-4C or equivalent material. Only venting components listed by a nationally recognized testing agency may be used.

This appliance may be installed with conventional, sidewall or vertical venting. Conventional vented appliances operate with negative pressure in the vent pipe and require a special vent adapter to increase the flue outlet diameter. Sidewall and vertically vented appliances operate with positive pressure in the vent pipe and may be directly connected to the flue outlet without the use of an increaser.

Consult the vent pipe manufacturer's instructions for minimum clearances to combustibile material for vent components. In the absence of instructions, the minimum clearance to combustibile material is six inches.

Consult vent pipe manufacturer's instructions for proper method of sealing vent pipe sections and fittings. In the absence of instructions, make sure that pipe and fittings are clean by swabbing with alcohol. Use Dow Corning 736 or 732 RTV, Polybar # 500 RTV or Sil-bond 4500 or 6500 to seal vent pipe. Do not use other sealants or adhesives except as expressly permitted by vent manufacturer's instructions.

Consult vent pipe manufacturer's instructions for vent system assembly. Follow vent pipe manufacturer's instructions if those instructions differ from this section.

Figure 9: Secondary Heat Exchanger

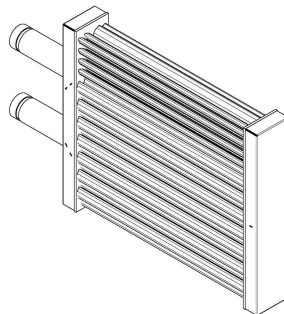

Table 6: CHRM Head Loss & Flow

Model	US GPM	ΔP - Ft.
62 – 152	2.0	0.05
202 – 302	4.0	0.1
402 – 602	10.0	0.4

A neutralizer cartridge is provided and must be installed in the line from the condensate collection pot to the drain. pH level of the condensate is to be checked regularly and neutralizing medium is to be replaced as required to maintain effectiveness. A neutralizer cartridge is available from the factory.

CONDENSING HEAT RECOVERY MODULE PIPING CONFIGURATIONS

Caution: If isolation valves are provided on the CHRM, the provision of a relief valve at the outlet of the secondary is recommended. This valve is to be sized at minimum for 10% of the input of the appliance and is to be piped to drain in a manner similar to the appliance relief valve.

CHRM IN SERIES WITH PRIMARY HEAT EXCHANGER (INTEGRATED LOOP)

The MicoFlame could be provided in condensing mode for a variety of application including domestic hot water and hydronic space heating.

The CHRM is intended to extract total (sensible and latent) heat from the flue gases downstream of the primary heat exchanger. As a result, condensation of moisture in the flue gas will take place on the CHRM surfaces and in the exhaust vent. This condensation is a natural outcome when efficiencies exceed 90%.

Recommended installation methods of the condensing MicoFlame will vary depending on the application and the expected water temperature variation of the system.

Examples of recommended installation for typical applications are shown on the next page:

Figure 10: Hydronic Heating Suggested Piping with CHRМ

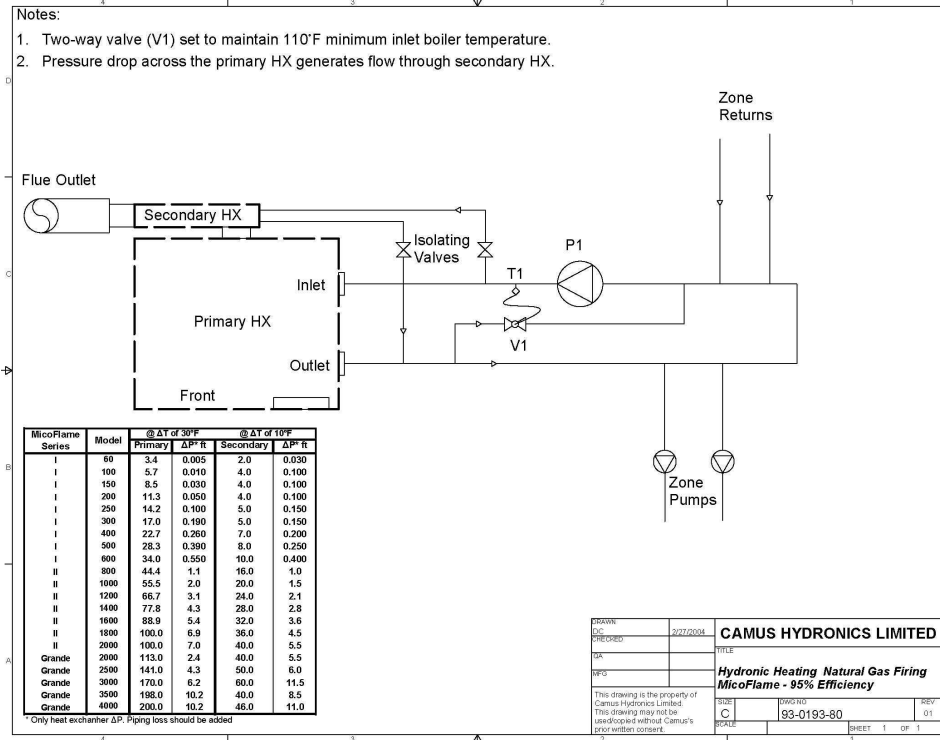
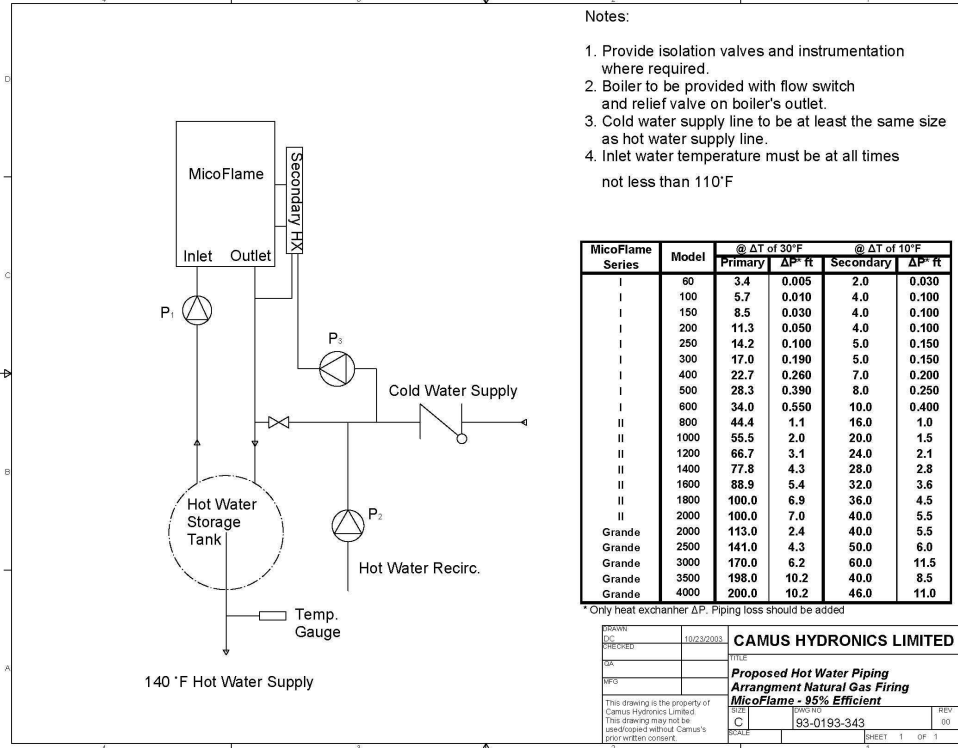

Figure 11: Domestic Hot Water Suggested Piping with CHRМ



17 INSTRUMENTATION AND CONTROLS

17.1 SAFETY CONTROLS

High Temperature Limit

The high temperature limit is located behind the appliance's access doors. A remote capillary bulb runs to a thermo-well on the outlet side of the inlet/outlet header. The appliance high limit is set at the factory to 210°F for hot water and 230°F for heating.

Air Flow Switch

An air proving switch is provided to prove the operation of the fan and adequate air flow to the burner. The pressure switch sensing point is at the air box below the combustion chamber. The LED indicator for air flow will not illuminate should the pressure switch detect a sustained low air condition.

Blocked Flue Switch

A normally-closed blocked flue switch is provided to shut off the burner in case of a blockage to the fan inlet or vent outlet.

17.2 CONTROL PANEL

The appliance is provided with a control panel at the front. Operating controls are installed inside the control box and are accessible by undoing the thumb screw and opening the door. The diagnostic information centre as well as the on/off switch, 24V fuse, and the appliance temperature controls reside on the control panel door.

Figure 12: Display, Appliance Temperature Controller and Indicating LED

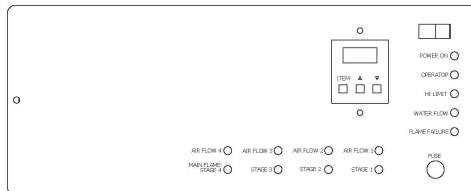

The Boiler Temperature Controller (BTC 1) for this appliance is a Camus 78-0017 SmartFlame control. The BTC 1 uses a Liquid Crystal Display (LCD) as a method of displaying boiler information. The BTC 1 is used to setup and monitor the operation of the system. The BTC 1 uses three push buttons for selecting and adjusting settings.

Boiler Temperature Controller Features:

It initiates the local call for heat and sets the target inlet (appliance inlet) water temperature. This controller accommodates heating and domestic hot water control with multiple modes of operation which provide set point as well as reset control. It provides the following:

- Readings of inlet and outlet temperatures and ΔT temperature rise
- Operation as an auto reset limit.
- Operation as a control for inlet water temperature.
- Optional tank mounted sensor used in conjunction with inlet sensor.
- Adjustable pump delay feature based on ΔT temperature difference between inlet and outlet temperatures. Accepts 1/6 hp. pump directly across terminals 13 & 14.
- Adjustable; target temp
- Display of run hours for maintenance purposes. Counter displays up to 999,999 hours.
- Flame failure signal 24 V.
- Molex connector for ease of service.

- Error message display.
- Test override feature to test pump operation and alarm.
- Pump exercising feature runs pump 10 seconds every three days of no pump operation.

The menu structure for the Appliance Temperature Control was designed to be intuitive and easy to use for a first time user. To maintain the MicoFlame Modulating boiler at its correct settings two levels of access are provided. User and Installer with an increasing amount of parameters that can be adjusted by the Installer. This is done to provide an easy means of communication for the end user and a more in-depth approach for factory installers when installing and troubleshooting.

Figure 13: Boiler Temperature Control (BTC 1)

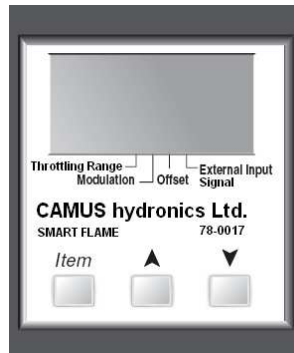

17.3 SETTING THE APPLIANCE TEMPERATURE CONTROLLER

Press and hold all three buttons (Item, ▲, ▼) simultaneously for 1 second. Pressing the ITEM key again will cause the last setting to be accepted. Once all settings have been made wait for 30 seconds for the BTC 1 to return to normal operating mode. To re-enter the Installer menu press and hold all three buttons (Item, ▲, ▼) simultaneously for 1 second. In normal operating mode the inlet temperature, outlet temperature, ΔT temperature and ON hours can be viewed by repeatedly pressing the ITEM key. If you wish to check the setting you will have to start again by pressing and holding the (Item, ▲, ▼) buttons simultaneously for 1 second, and then use the ITEM key to scroll through the settings. After checking the settings allow the BTC 1 to return to normal operation on its own.

17.4 MODES OF OPERATION

Mode 1: Constant Temperature Control

This mode is designed for hydronic heating or domestic hot water (DHW). Once a heat demand is present, the BTC 1 turns on the appliance pump and modulates the boiler burner to maintain the boiler target at the boiler inlet sensor. A heat demand is generated when a 24VAC is applied across CD (common demand) and Ht D (heat demand). Once voltage is applied, the BTC 1 turns on the Dem 1 segment in the display.

If the inlet sensor is ½ (half) of the differential below the BOIL TARGET, the BTC 1 then changes the proportional modulation output to the START modulation setting, the Stage contact (pins 15 & 16) close to proceed to trial for ignition. The burner remains at minimum modulation until the flame is proved and then the modulating output changes the boiler burner output to maintain the programmed boiler target temperature at the inlet sensor. If the inlet sensor reaches ½ (half) of the differential above BOIL TARGET setting, the burner shuts off. Once the external heat demand is removed, the BTC 1 turns off the appliance and operates the boiler pump based on the PUMP DELAY setting.

The water temperature is controlled based on a fixed setpoint (BOIL TARGET). The setpoint for inlet water is pre-set to 120°F and the auto re-set limit is set to 210°F and is fixed. In addition to the auto reset limit the factory installs a manual re-set limit set to 250°F.

Figure 14: Mode 1 Piping & Electrical Layout

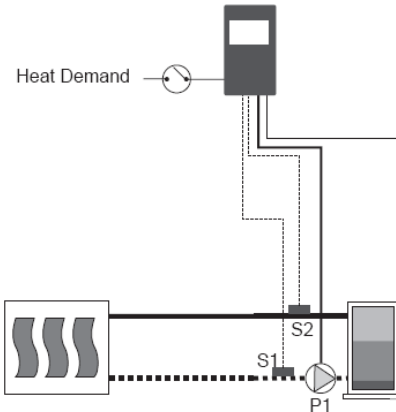

Mode 2: Constant Temperature Control at System Sensor

This mode is designed for hydronic heating. Once a heat demand is present, the BTC 1 modulates the boiler burner to maintain the boiler target at the system sensor. A heat demand is generated when 24VAC is applied across CD (common demand) and Ht D (heat demand). Dem 1 on the LCD display is lit.

If the system sensor is ½ (half) of the differential below the BOIL TARGET, the BTC 1 then changes the proportional modulation output to the START modulation setting, the Stage contact (pins 15 & 16) closes to proceed to trial for ignition. The burner remains at minimum modulation until the flame is proved and then the modulating output changes the boiler burner output to maintain the programmed boiler target temperature at the system sensor. If the system sensor reaches ½ (half) of the differential above BOIL TARGET setting, the burner shuts off. Once the external heat demand is removed, the BTC 1 turns off the appliance and operates the boiler pump based on the PUMP DELAY setting. In this case, it is imperative that the system pump operates continuously in order to provide constant circulation past the system sensor.

The water temperature is controlled based on a fixed setpoint (BOIL TARGET). The setpoint for inlet water is pre-set to 120°F and the auto re-set limit is set to 210°F and is fixed. In addition to the auto reset limit the factory installs a manual re-set limit set to 250°F.

Figure 15: Mode 2 Piping & Electrical Layout

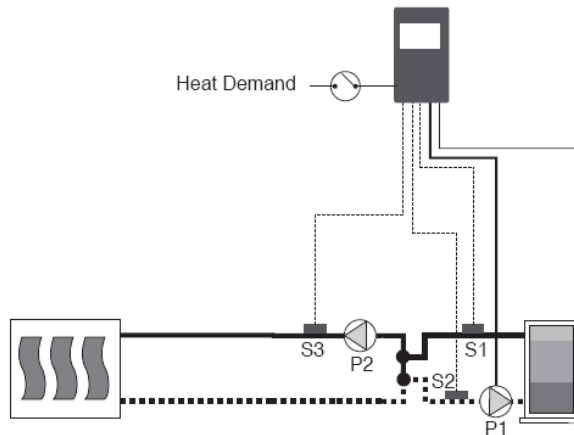

Mode 3: Dedicated Domestic Hot Water Operation

This mode is designed for domestic hot water. A DHW sensor must be inserted into a temperature immersion well within the DHW tank to function properly. The BTC 1 modulates the boiler based on the boiler inlet sensor to maintain a tank temperature at the DHW sensor.

An internal heat demand is generated when the DHW sensor drops $\frac{1}{2}$ (half) of the tank differential setting below the desired DHW tank temperature. Dem 1 is lit on the LCD screen.

The BTC 1 then changes the modulation output to the START modulation setting and closes the Stage contact (pins 15 & 16) to proceed to trial for ignition. The burner remains at minimum modulation until the flame is proved and then modulating output changes the boiler output to maintain the programmed boiler target temperature at the boiler inlet sensor. Once the DHW tank reaches $\frac{1}{2}$ of the tank differential above the TANK TARGET setting, the internal demand is removed and the boiler burner is shut off. The pump circulates until the PUMP DELAY timer expires.

The TANK TARGET setting is used to set the desired DHW tank setpoint. The set-point for inlet water is pre-set to 130°F and can be adjusted, the auto re-set limit is set to 210°F and is fixed. In addition to the auto reset limit the factory installs a manual re-set limit set to 210°F.

Figure 16: Mode 3 Piping & Electrical Layout

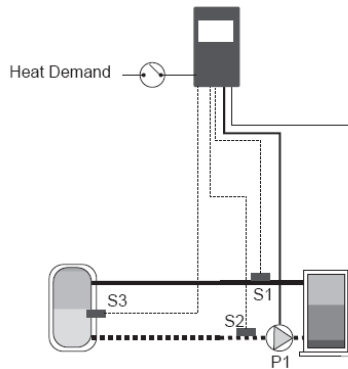

Mode 4: Outdoor Reset using Boiler Inlet Sensor

This mode is designed for hydronic heating. Once a heat demand is present, the BTC 1 turns on the appliance pump and modulates the boiler to maintain the calculated outdoor reset target at the boiler inlet sensor. Outdoor reset calculates the boiler target temperature based on the outdoor air temperature and reset ratio.

A heat demand is generated when a voltage between 24VAC and 120VAC is applied across CD (common demand) and Ht D (heat demand). Once voltage is applied, the BTC 1 turns on the Dem 1 segment in the display. If warm weather shut down (WWSD) is activated, the WWSD segment is lit.

If WWSD is not activated and the inlet sensor is $\frac{1}{2}$ (half) of the differential below the calculated BOIL TARGET, the BTC 1 then changes the modulation output to the START modulation setting and closes the Stage contacts (pins 15 & 16) to proceed to trial for ignition. The burner remains at minimum modulation until the flame is proved and then modulating output changes the boiler output to maintain the calculated boiler target temperature at the inlet sensor. If the inlet sensor reaches $\frac{1}{2}$ (half) of the differential above the BOIL TARGET, the appliance is shut off. The boiler pump continues to circulate until the PUMP DELAY timer expires.

The water temperature is controlled based on a calculated boiler target temperature. The boiler start (BOIL START) temperature is pre-set to 70°F and the auto re-set limit is set to 210°F and is fixed. In addition to the auto reset limit the factory installs a manual re-set limit set to 250°F.

Figure 17: Mode 4 Piping & Electrical Layout

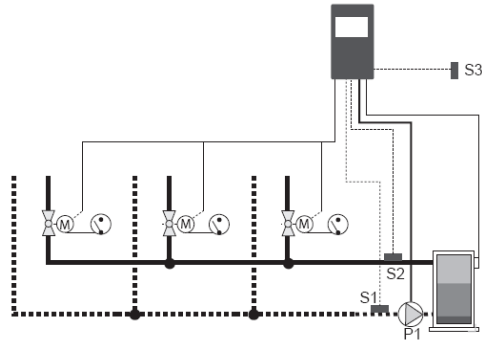

Mode 5: Outdoor Reset using System Sensor

This mode is designed for hydronic heating. Once a heat demand is present, the BTC 1 turns on the appliance pump and modulates the boiler to maintain the calculated outdoor reset target at the system sensor. Outdoor reset calculates the boiler target temperature based on the outdoor air temperature and reset ratio.

A heat demand is generated when a voltage between 24VAC and 120VAC is applied across CD (common demand) and Ht D (heat demand). Once voltage is applied, the BTC 1 turns on the Dem 1 segment in the display. If warm weather shut down (WWSD) is activated, the WWSD segment is lit.

If WWSD is not activated and the system sensor is ½ (half) of the differential below the calculated BOIL TARGET, the control then changes the modulation output to the START modulation setting and closes the Stage contacts (pins 15 & 16) to proceed to trial for ignition. The burner remains at minimum modulation until the flame is proved and then the modulating output changes the boiler output to maintain the calculated boiler target temperature at the system sensor. If the system sensor reaches ½ (half) of the differential above the BOIL TARGET, the appliance is shut off. The appliance pump continues to circulate until the PUMP DELAY timer expires. In this case, it is imperative that the system pump operates continuously in order to provide constant circulation past the system sensor.

The water temperature is controlled based on a calculated boiler target temperature. The boiler start (BOIL START) temperature is pre-set to 70°F and the auto re-set limit is set to 210°F and is fixed. In addition to the auto reset limit the factory installs a manual re-set limit set to 250°F.

Figure 18: Mode 5 Piping & Electrical Layout

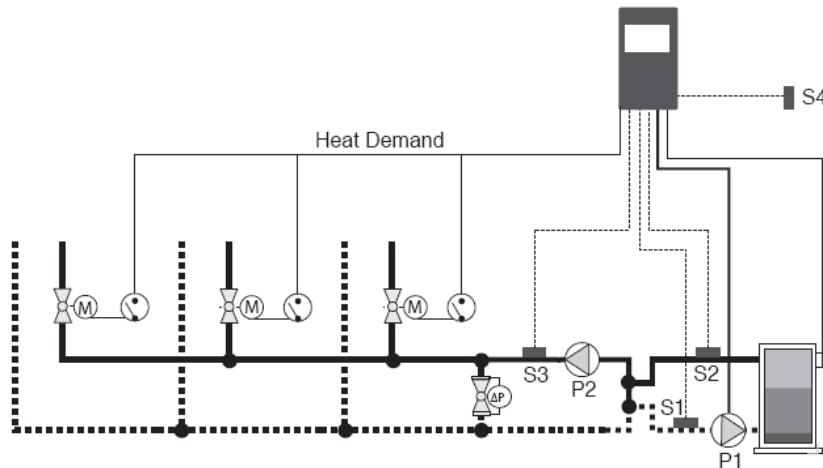

Mode 6: External Target Temperature using Boiler Inlet Sensor

The external input signal can be provided from a BMS, EMS or a tekmar tN4 System Control. The external input signal creates an internal demand and changes the boiler target according to a linear scale. The BTC 1 modulates the boiler to maintain the boiler target at the inlet sensor.

An internal heat demand is generated when an analog positive 2-10VDC signal is applied to the +V input and a negative DC signal is applied to the Com/- input.

The following table shows the various signals required to generate various Target temperatures.

Table 7: External Signal Cross Reference Chart

4-20 mA	Boiler Target	0-10V (dc)*	Boiler Target
0	--- (OFF)	0	--- (OFF)
2	--- (OFF)	1	50°F (10°C)
4	50°F (10°C)	2	68°F (20°C)
6	70°F (21°C)	3	86°F (30°C)
8	90°F (32°C)	4	103°F (39°C)
10	110°F (43°C)	5	121°F (49°C)
12	130°F (54°C)	6	139°F (59°C)
14	150°F (66°C)	7	157°F (69°C)
16	170°F (77°C)	8	174°F (79°C)
18	190°F (88°C)	9	192°F (89°C)
20	210°F (99°C)	10	210°F (99°C)

* requires 500Ω resistor

A 4-20mA signal can be converted to a 2-10VDC signal by installing a 500Ω resistor on the external input signal device's terminal.

If the inlet sensor is ½ (half) of the differential below the Boiler Target, the BTC 1 then changes the proportional modulation output to the START modulation setting, the Stage contact (pins 15 & 16) closes to proceed to trial for ignition. The burner remains at minimum modulation until the flame is proved and then the modulating output changes the boiler burner output to maintain the programmed boiler target temperature at the inlet sensor. If the inlet sensor reaches ½ (half) of the differential above Boiler Target, the burner shuts off. Once the external heat demand is removed, the BTC 1 turns off the appliance and operates the boiler pump based on the PUMP DELAY setting.

The auto re-set limit is set to 210°F and is fixed. In addition to the auto reset limit the factory installs a manual re-set limit set to 250°F.

Figure 19: Mode 6 Piping Schematic

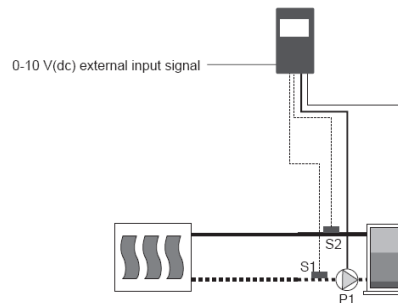

Mode 7: External Target Temperature using System Temperature Sensor

The external input signal can be provided from a BMS, EMS or a tekmar tN4 System Control. The external input signal creates an internal demand and changes the boiler target according to a linear scale. The control modulates the boiler to maintain the boiler target at the outlet sensor.

An internal heat demand is generated when an analog positive 2-10VDC signal is applied to the +V input and a negative DC signal is applied to the Com/- input.

Table 7 shows the relationship between various external signals to the boiler target temperature. A 4-20mA signal can be converted to a 2-10VDC signal by installing a 500Ω resistor on the external input signal device's terminal.

If the system sensor is ½ (half) of the differential below the Boiler Target, the BTC 1 then changes the proportional modulation output to the START modulation setting, then closes the Stage contact (pins 15 & 16) to proceed to trial for ignition. The burner remains at minimum modulation until the flame is proved and then the modulating output changes the boiler burner out to maintain the programmed boiler target temperature at the system sensor. If the inlet sensor reaches ½ (half) of the differential above Boiler Target, the burner shuts off. Once the external heat demand is removed, the BTC 1 turns off the appliance and operates the boiler pump based on the PUMP DELAY setting.

The auto reset limit is set to 210°F and is fixed. In addition to the auto reset limit, Camus installs a manual reset limit set to 250°F.

Figure 20: Mode 7 Piping & Electrical Layout

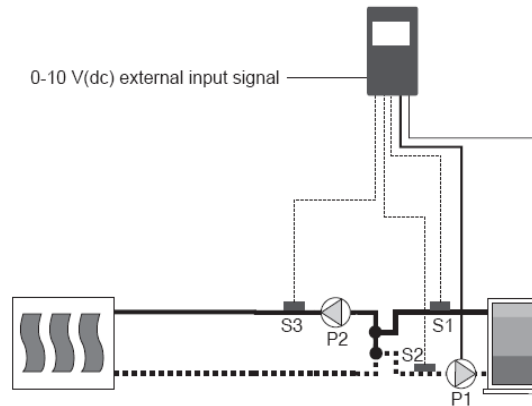

Mode 8: External Direct Drive Operation

This mode is designed only for hydronic heating operation. This mode allows for an external control to operate the boiler through an analog direct drive input signal provided by a boiler sequencing control, such as, the S12 Sequencer. When operating in this mode the external heat demand and DHW demand are disabled.

An external boiler sequencer provides a positive 0-10 VDC input signal to the control at +V(in), and the negative signal is applied to the Com/- input.

The boiler remains off while the direct drive input signal range is between 0 to 0.5VDC. Once the direct drive input signal reaches 0.5VDC the control turns on the appliance pump and changes the modulating output to Start Modulation level until the flame is proved and then the modulating output is adjusted to track the direct drive input signal up to the maximum of 10VDC which is equivalent to maximum input rate. When the direct drive signal modulates down to 0.5VDC, the boiler operates at minimum fire. When the signal drops below 0.5VDC the burner is shut off and the pump continues to circulate until the PUMP DELAY timer expires, whereupon the pump shuts off.

The external boiler sequencer can specify the boiler inlet temperature. However, the BOIL MAX setting limits the highest temperature at the outlet sensor. If the outlet temperature exceeds 210°F, the modulating output immediately changes to 0% and the burner is shut off. The burner is to remain off until the minimum off timer is satisfied and the boiler outlet temperature falls by 2°F (1°C) below the BOIL MAX setting.

Figure 21: Mode 8 Piping & Electrical Layout

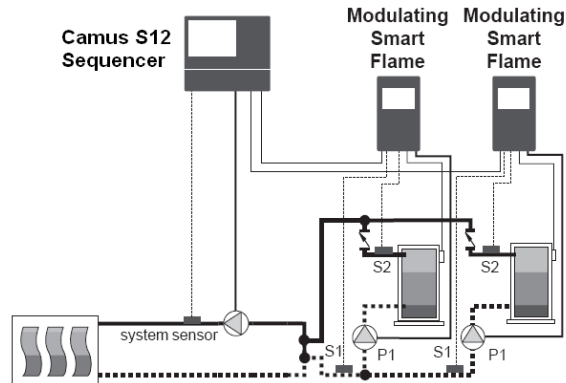

18 MICROFLAME CONTROL PANEL

Figure 22: BTC 1 Display Panel

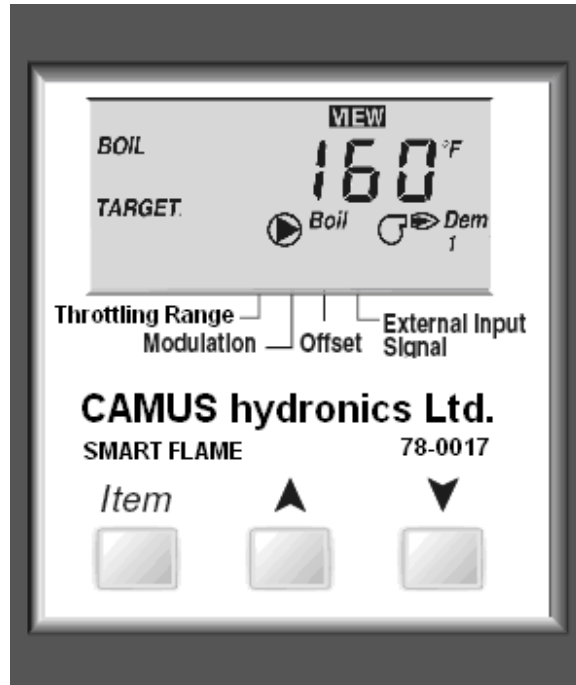

Figure 23: BTC Key Functions



Table 8: BTC Key Functions





KEY	KEY DESCRIPTION
Item	The abbreviated name of the selected item will be displayed in the item field of the display. To view the next item, press the Item button.
▲	Increase a parameter value.
▼	Decrease a parameter value.

Levels of Access

View – Access to general boiler and display settings and will allow adjustments to the central heating and domestic hot water setpoint.

Adjust – Access to all user parameters and allows for changes to additional boiler parameters to allow for ease of startup and serviceability.







18.1 GENERAL SYMBOL DESCRIPTION

SYMBOL	SYMBOL NAME	SYMBOL DESCRIPTION
 Boil	Boiler Pump	Shown when boiler pump is in operation
 DHW	DHW Pump	Shown when DHW pump is in operation
Dem 1	Heat Demand	Shown when heat demand is present
Dem 2	Flame Proof	Shown when flame signal is proven
	Burner	Shown when burner is on
	Warning	Shown when an error is present
	Pointers	Shows the operation as indicated by the text
WWSD	WWSD	Displays when the control is in Warm Weather Shutdown

18.2 MODE 1 & 2: SETPOINT OPERATION: VIEW DISPLAY

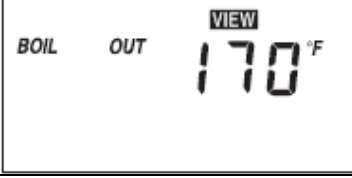
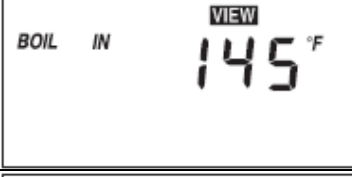
From the Home display;

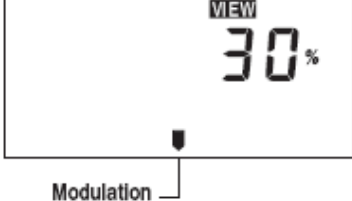



- 1) Press [ITEM] to view the following parameters:

Display	Parameter Name	Parameter Description	Parameter Range
	Boiler Target Temperature	To provide a target setpoint for the heating system. Setpoint is controlled to the inlet sensor	---, 35 to 266°F (---, 2 to 130°C)
	System Temperature	System Temperature of Primary Loop NOTE: This parameter is only available in Mode 2	14 to 266°F (-10 to 130°C)
	Boiler Outlet Temperature	Real-time Outlet Temperature to Boiler	14 to 266°F (-10 to 130°C)
	Boiler Inlet Temperature	Real-time Inlet Temperature to Boiler	14 to 266°F (-10 to 130°C)
	Boiler Delta T	Real-time temperature difference between the outlet sensor and the inlet sensor.	-99 to 252°F (-72 to 140°C)
	Modulation	Real-time modulating output percentage	0 to 100%
	Total Run Time Since Installation	Monitors the amount of operational time since the MicoFlame was installed. The first two digits are the number of thousands of hours and the three digit display shows the number of hundreds of hours. Press (▲, ▼) simultaneously to reset the counter	Alternates between 00 and 999

18.3 MODE 1 & 2: SETPOINT OPERATION: ADJUST DISPLAY

From the Home display;

- 1) Press (Item, ▲, ▼) simultaneously to view the following parameters:

Display	Parameter Name	Parameter Description	Parameter Range
	Mode	Operating mode for the boiler. NOTE: A complete description of each mode can be found in section 8.4 Modes of Operation in this manual.	1 to 8 Default = 1
	Boiler Target Temperature	To provide a target setpoint for the heating system. Setpoint is controlled to the inlet sensor	70 to 220°F (21 to 104°C) Default = 120°F (49°C)
	Differential Temperature	To provide a modulation rate above and below the Boiler Target temperature. For example, if the value is 10°F and the Boiler Target is 160°F the boiler will begin to modulate at 155°F and shut off at 165°F.	Au, 2 to 42°F (Au, -17 to 6°C) Default = Au
	Pump Delay	Boiler post pump time after burner has shut off, in seconds.	OFF, 0:20 to 9:55 min, On Default = 1:00 min
	Temperature Units	Select the desired unit of measurement	°F, °C Default = °F

18.4 MODE 3: DEDICATED DOMESTIC HOT WATER OPERATION: VIEW DISPLAY

From the Home display;



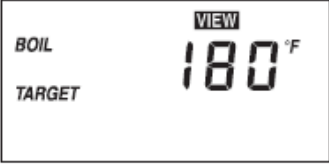
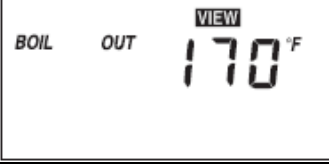
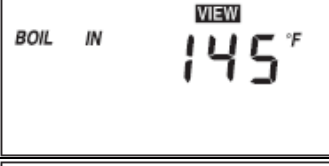
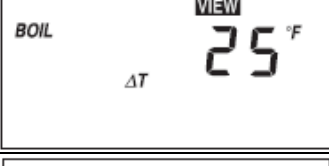
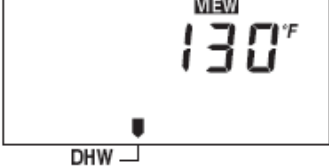
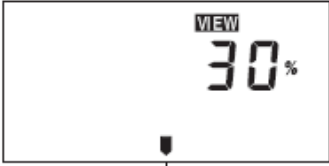
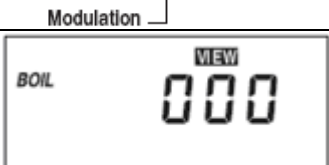



- 1) Press [ITEM] to view the following parameters:

Display	Parameter Name	Parameter Description	Parameter Range
	Boiler Target Temperature	To provide a target setpoint for the heating system. Setpoint is controlled to the inlet sensor	---, 35 to 266°F (-10, 2 to 130°C)
	Boiler Outlet Temperature	Real-time Outlet Temperature to Boiler	14 to 266°F (-10 to 130°C)
	Boiler Inlet Temperature	Real-time Inlet Temperature to Boiler	14 to 266°F (-10 to 130°C)
	Boiler Delta T	Real-time temperature difference between the outlet sensor and the inlet sensor.	-99 to 252°F (-72 to 122°C)
	DHW Temperature	Real-time DHW Temperature	14 to 266°F (-10 to 130°C)
	Modulation	Real-time modulating output percentage	0 to 100%
	Total Run Time Since Installation	Monitors the amount of operational time since the MicoFlame was installed. The first two digits are the number of thousands of hours and the three digit display shows the number of hundreds of hours. Press (▲, ▼) simultaneously to reset the counter	Alternates between 00 and 999

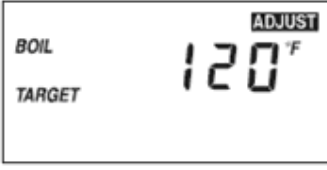
18.5 MODE 3: DEDICATED DOMESTIC HOT WATER OPERATION: ADJUST DISPLAY

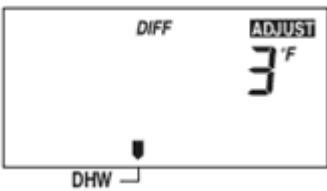
From the Home display;







- 1) Press (Item, ▲, ▼) simultaneously to view the following parameters:

Display	Parameter Name	Parameter Description	Parameter Range
	Mode	Operating mode for the boiler. NOTE: A complete description of each mode can be found in section 8.4 Modes of Operation in this manual.	1 to 8 Default = 1
	Boiler Target Temperature	To provide a target setpoint for the heating system. Setpoint is controlled to the inlet sensor	OFF, 70 to 220°F (OFF, 21 to 104°C) Default = 120°F (82°C)
	DHW Target Temperature	To provide a target setpoint for the DHW system. Setpoint is controlled to the DHW sensor	OFF, 70 to 190°F (OFF, 21 to 88°C) Default = 140°F (54°C)
	DHW Differential	To provide a modulation rate above and below the DHW Target Temperature. For example, if the value is 10°F and the DHW Target Temperature is 160°F the boiler will begin to modulate at 155°F and shut off at 165°F.	2 to 10°F (1 to 5°C) Default = 3°F (1°C)
	Differential Temperature	To provide a modulation rate above and below the Boiler Target temperature. For example, if the value is 10°F and the Boiler Target is 160°F the boiler will begin to modulate at 155°F and shut off at 165°F.	Au, 2 to 42°F (Au, -17 to 5°C) Default = Au
	Pump Delay	Boiler post pump time after burner has shut off, in seconds.	OFF, 0:20 to 9:55 min, On Default = 1:00 min
	Temperature Units	Select the desired unit of measurement	°F, °C Default = °F

18.6 MODE 4 & 5: OUTDOOR RESET OPERATION: VIEW DISPLAY

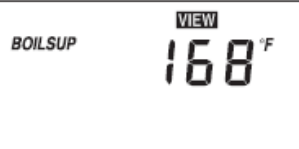
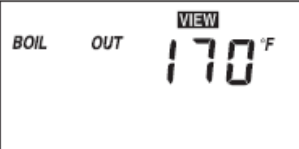
From the Home display;

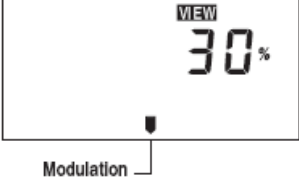





- 1) Press [ITEM] to view the following parameters:

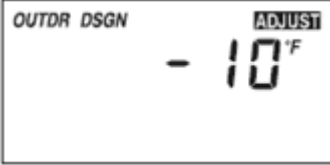

Display	Parameter Name	Parameter Description	Parameter Range
	Outdoor Temperature	Real-time Outdoor Temperature	-60 to 190°F (-51 to 88°C)
	Boiler Target Temperature	To provide a target setpoint for the heating system. Setpoint is controlled to the inlet sensor	---, 35 to 266°F (---, 2 to 130°C)
	System Temperature	System Temperature of Primary Loop NOTE: This parameter is only available in Mode 5	14 to 266°F (-10 to 130°C)
	Boiler Outlet Temperature	Real-time Outlet Temperature	14 to 266°F (-10 to 130°C)
	Boiler Inlet Temperature	Real-time Inlet Temperature	14 to 266°F (-10 to 130°C)
	Boiler Delta T	Real-time temperature difference between the outlet sensor and the inlet sensor.	-99 to 252°F (-72 to 122°C)
	Modulation	Real-time modulating output percentage	0 to 100%
	Total Run Time Since Installation	Monitors the amount of operational time since the MicoFlame was installed. The first two digits are the number of thousands of hours and the three digit display shows the number of hundreds of hours. Press (▲, ▼) simultaneously to reset the counter	Alternates between 00 and 999

18.7 MODE 4 & 5: OUTDOOR RESET OPERATION: ADJUST DISPLAY

From the Home display;

- 1) Press (Item, ▲, ▼) simultaneously to view the following parameters:



Display	Parameter Name	Parameter Description	Parameter Range
	Mode	Operating mode for the boiler. NOTE: A complete description of each mode can be found in section 8.4 Modes of Operation in this manual.	1 to 8 Default = 1
	Outdoor Start Temperature	Outdoor starting temperature used in the reset ratio for the heating system. Typically set to the desired building temperature.	35 to 85°F (2 to 29°C) Default = 60°F (21°C)
	Outdoor Design Temperature	Outdoor design temperature used in the reset ratio for the heating system. Set to the coldest annual outdoor temperature in the local area.	-60 to 50°F (-51 to 10°C) Default = -10°F (-23°C)
	Boiler Start Temperature	Starting water temperature used in the reset ratio calculation for the heating system. Typically set to the desired building temperature.	35 to 150°F (2 to 66°C) Default = 70°F (21°C)
	Boiler Design Temperature	Boiler design water temperature used in the reset ratio calculation for the heating system. Set to the boiler water temperature required to heat the building on the coldest annual outdoor temperature.	70 to 230°F (21 to 110°C) Default = 180°F (82°C)
	Differential Temperature	To provide a modulation rate above and below the Boiler Target temperature. For example, if the value is 10°F and the Boiler Target is 160°F the boiler will begin to modulate at 155°F and shut off at 165°F.	Au, 2 to 42°F (Au, -16 to 5°C) Default = Au
	Pump Delay	Boiler post pump time after burner has shut off, in seconds.	OFF, 0:20 to 9:55 min, On Default = 1:00 min

Display	Parameter Name	Parameter Description	Parameter Range
	Warm Weather Shutdown Temperature	Warm weather shutdown temperature using outdoor reset.	35 to 105°F, OFF (2 to 41°C, OFF) Default = 0:20 min
	Temperature Units	Select the desired unit of measurement	°F, °C Default = °F

18.8 MODE 6 & 7: EXTERNAL TARGET TEMPERATURE INPUT OPERATION: VIEW DISPLAY

From the Home display;

- 1) Press [ITEM] to view the following parameters:

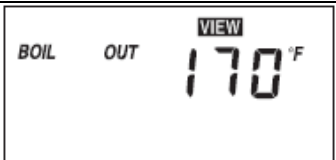
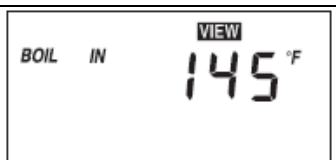
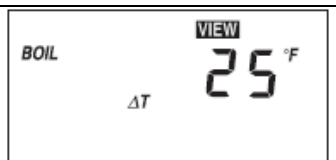
Display	Parameter Name	Parameter Description	Parameter Range
	Boiler Target Temperature	To provide a target setpoint for the heating system. Setpoint is controlled to the inlet sensor.	---, 35 to 266°F (-10, 2 to 130°C)
	System Temperature	Real-time System Temperature NOTE: This parameter is only available in Mode 7	14 to 266°F (-10 to 130°C)
	Boiler Outlet Temperature	Real-time Outlet Temperature to Boiler	14 to 266°F (-10 to 130°C)
	Boiler Inlet Temperature	Real-time Inlet Temperature to Boiler	14 to 266°F (-10 to 130°C)
	Boiler Delta T	Real-time temperature difference between the outlet sensor and the inlet sensor.	-99 to 252°F (-72 to 122°C)

Display	Parameter Name	Parameter Description	Parameter Range
<p>The display shows the word 'VIEW' at the top, the number '30' followed by a percent sign, and the word 'Modulation' at the bottom.</p>	Modulation	Real-time modulating output percentage	0 to 100%
<p>The display shows the word 'BOIL' on the left, 'VIEW' at the top, and the number '000' in the center.</p>	Total Run Time Since Installation	Monitors the amount of operational time since the MicoFlame was installed. The first two digits are the number of thousands of hours and the three digit display shows the number of hundreds of hours. Press (▲, ▼) simultaneously to reset the counter	Alternates between 00 and 999

18.9 MODE 6 & 7: EXTERNAL TARGET TEMPERATURE INPUT OPERATION: ADJUST DISPLAY

From the Home display;





- 1) Press (Item, ▲, ▼) simultaneously to view the following parameters:

Display	Parameter Name	Parameter Description	Parameter Range
<p>The display shows the word 'MODE' on the left, 'ADJUST' at the top right, and the number '6' in the center.</p>	Mode	Operating mode for the boiler. NOTE: A complete description of each mode can be found in section 8.4 Modes of Operation in this manual.	1 to 8 Default = 1
<p>The display shows the word 'DIFF' on the left, 'ADJUST' at the top right, and the letters 'Au' in the center.</p>	Differential Temperature	To provide a modulation rate above and below the Boiler Target temperature. For example, if the value is 10°F and the Boiler Target is 160°F the boiler will begin to modulate at 155°F and shut off at 165°F.	Au, 2 to 42°F (Au, -17 to 6°C) Default = Au
<p>The display shows the word 'DLY' on the left, 'ADJUST' at the top right, and '0:20 min' in the center with a play button icon below the number.</p>	Pump Delay	Boiler post pump time after burner has shut off, in seconds.	OFF, 0:20 to 9:55 min, On Default = 1:00 min
<p>The display shows the word 'ADJUST' at the top right and the letter 'F' in the center.</p>	Temperature Units	Select the desired unit of measurement	°F, °C Default = °F

18.10 MODE 8: EXTERNAL DRIVE OPERATION: VIEW DISPLAY

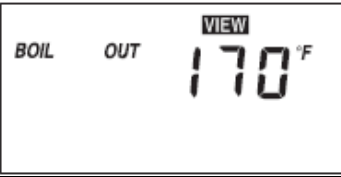
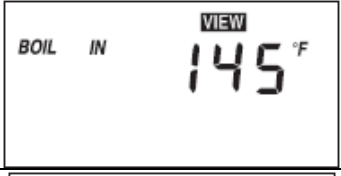
From the Home display;

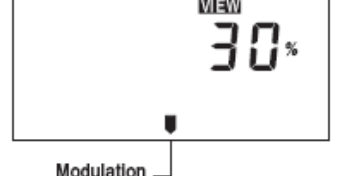

- 1) Press [ITEM] to view the following parameters:

Display	Parameter Name	Parameter Description	Parameter Range
	Boiler Outlet Temperature	Real-time Outlet Temperature to Boiler	14 to 266°F (-10 to 130°C)
	Boiler Inlet Temperature	Real-time Inlet Temperature to Boiler	14 to 266°F (-10 to 130°C)
	Boiler Delta T	Real-time temperature difference between the outlet sensor and the inlet sensor.	-99 to 252°F (-72 to 122°C)
	Modulation	Real-time modulating output percentage	0 to 100%
	Total Run Time Since Installation	Monitors the amount of operational time since the MicoFlame was installed. The first two digits are the number of thousands of hours and the three digit display shows the number of hundreds of hours. Press (▲, ▼) simultaneously to reset the counter	Alternates between 00 and 999

18.11 MODE 8: EXTERNAL DRIVE OPERATION: ADJUST DISPLAY



From the Home display;

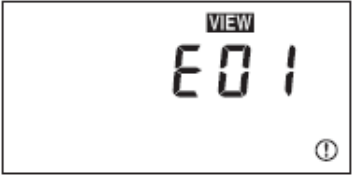
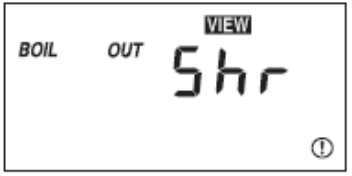
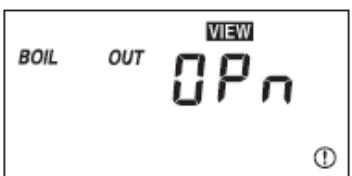

- 1) Press (Item, ▲, ▼) simultaneously to view the following parameters:

Display	Parameter Name	Parameter Description	Parameter Range
	Mode	Operating mode for the boiler. NOTE: A complete description of each mode can be found in section 8.4 Modes of Operation in this manual.	1 to 8 Default = 1
	Pump Delay	Boiler post pump time after burner has shut off, in seconds.	OFF, 0:20 to 9:55 min, On Default = 1:00 min
	Temperature Units	Select the desired unit of measurement	°F, °C Default = °F

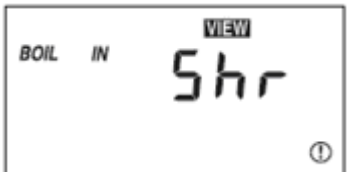
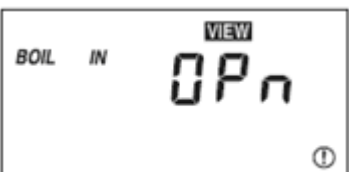
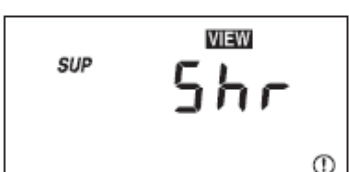
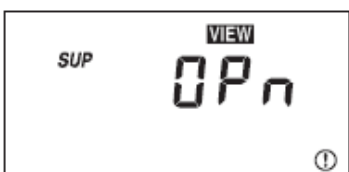
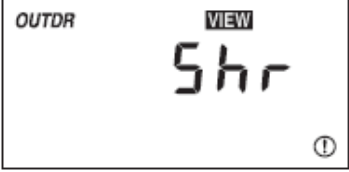
18.12 ERROR MESSAGES

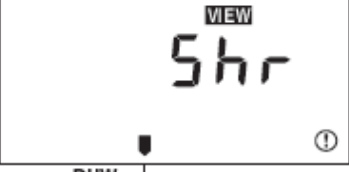
Error Message	Description
	The control was unable to read a piece of information its EEPROM memory. The control will stop operation until all settings in the Adjust menu have been checked by the installer.
	Outlet Sensor Short Circuit. If the inlet sensor is operational, the control will operate using the inlet sensor. Otherwise, the control will not operate the burner. Test the outlet sensor and related wiring. The error message will clear once the error condition is corrected and a button is pressed.
	Outlet Sensor Open. If the inlet sensor is operational, the control will operate using the inlet sensor. Otherwise, the control will not operate the burner. Test the outlet sensor and related wiring. The error message will clear once the error condition is corrected and a button is pressed.

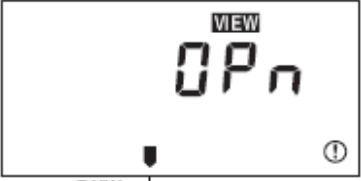
Error Message	Description
	<p>Inlet Sensor Short Circuit The boiler will continue operation.</p> <p>Test the inlet sensor and related wiring. The error message will clear once the error condition is corrected and a button is pressed.</p>
	<p>Inlet Sensor Open The boiler will continue operation</p> <p>Test the inlet sensor and related wiring. The error message will clear once the error condition is corrected and a button is pressed.</p>
	<p>System Sensor Short Circuit If the outlet sensor is operational, the boiler will operate using the outlet sensor. If the outlet sensor is not available and the inlet sensor is operational, the boiler will operate using the inlet sensor. Otherwise, the control will not operate the burner.</p> <p>Test the supply sensor and related wiring. The error message will clear once the error condition is corrected and a button is pressed.</p>
	<p>System Sensor Open If the outlet sensor is operational, the boiler will operate using the outlet sensor. If the outlet sensor is not available and the inlet sensor is operational, the boiler will operate using the inlet sensor. Otherwise, the control will not operate the burner.</p> <p>Test the supply sensor and related wiring. The error message will clear once the error condition is corrected and a button is pressed.</p>
	<p>Outdoor Sensor Short Circuit The BTC assumes an outdoor temperature of 32°F (0°C) and continues operation.</p> <p>Test the outdoor sensor and related wiring. The error message will clear once the error condition is corrected and a button is pressed.</p>
	<p>Outdoor Sensor Open The BTC assumes an outdoor temperature of 32°F (0°C) and continues operation.</p> <p>Test the outdoor sensor and related wiring. The error message will clear once the error condition is corrected and a button is pressed.</p>
	<p>DHW Sensor Short Circuit The control will not operate the burner.</p> <p>Test the DHW sensor and related wiring. The error message will clear once the error condition is corrected and a button is pressed.</p>

Error Message	Description
	<p>DHW Sensor Open The control will not operate the burner.</p> <p>Test the DHW sensor and related wiring. The error message will clear once the error condition is corrected and a button is pressed.</p>
	<p>Flame Proof Error</p> <p>Flame was not proved within 120 seconds of Demand 1</p>

19 PILOT AND MAIN BURNER FLAMES

To maintain safe operation and the greatest efficiency of the boiler, check the main burner and pilot burner every six months for proper flame characteristics.

19.1 MAIN BURNER

The main burner, Figure 24 for models 60 -300 and Figure 25 for models 400 – 600 should display the following characteristics;

- Acceptable CO and CO₂ levels for complete combustion.
- Light off smoothly.
- Reasonably quiet while running.
- Stable flame with minimum of lifting.
- Blue flame with natural gas, yellow tips with propane gas

Figure 24: MicoFlame 60 – 300 Burner Assembly

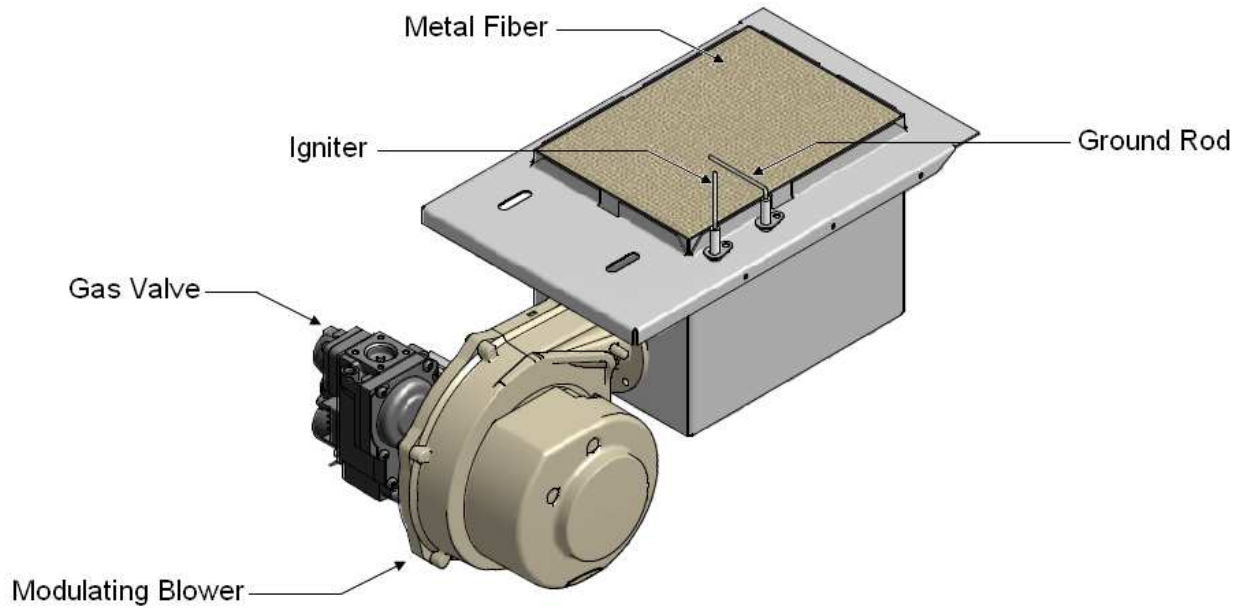
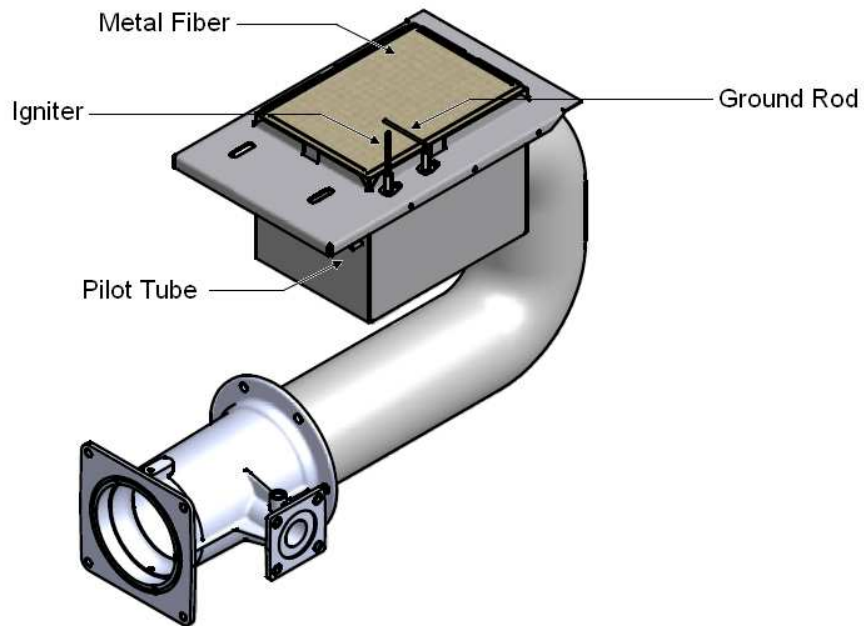

Figure 25: MicoFlame 400 – 600 Burner Assembly



If burner characteristics do not match the above, check for proper air box pressure. Also look for accumulation of lint and other foreign material at fan air inlets. Typical air box settings are as follows:

Table 9: Air Box Settings

MODEL	AIR BOX " W.C. (with burner firing)	FLUE SWITCH RECYCLE POINT " W.C
060	0.20	0.15
100	0.25	0.20
150	0.30	0.25
200	0.35	0.30
250	0.38	0.33
300	0.40	0.35
400	0.80	0.70
500	0.90	0.80
600	1.00	0.90

Depending on field conditions air box pressures will have to be adjusted accordingly. Always set the appliance for a CO₂ level in the range listed in Table 10.

Table 10: Combustion Values

		Natural Gas		Propane	
		CO ₂	CO	CO ₂	CO
Non-Condensing	Max. Fire	7.5% - 8.5%	< 50 PPM	9.0% - 10.0%	< 50 PPM
	Min. Fire	7.0% - 7.5%	< 50 PPM	8.5% - 9.0%	< 50 PPM
Condensing	Max. Fire	8.5% - 9.0%	< 50 PPM	10.0% - 10.5%	< 50 PPM
	Min. Fire	7.5% - 8.0%	< 50 PPM	9.0% - 9.5%	< 50 PPM

A qualified service technician should follow this procedure when burner needs cleaning.

1. Shut off power and close main manual gas valve.
 - Allow burner to cool before removal.
2. Remove access cover screws.
 - Disconnect pilot gas at bulkhead fitting.
 - Disconnect ground wire and ignition wire.
 - Remove two wing nuts holding down burner.
 - Gently pull down and forward to disengage burner.
 - Remove burner being careful to not damage the igniter or ground electrodes.
3. Thoroughly clean burner. Check all ports and air channels for blockage.
4. Reinstall the burner being careful to fully engage the back of the burner box into the retaining slot in the combustion chamber base. Failure to properly locate the burner will result in erratic flame operation with the possibility of delayed ignition on light off.
5. Restore electrical power and gas supply to the boiler.
 - Following the lighting instructions put the boiler back into operation
 - Check for gas leaks and proper boiler and vent operation.

19.2 PILOT BURNER

Turn the pilot firing valve to off position and allow the appliance to try for ignition. Observe the spark making sure that it is strong and continuous.

If the spark is not acceptable the igniter will have to be adjusted. This can be readily accomplished after removing the main burner.

The spark gap should be 1/8" to 3/16". Make sure that the electrode does not appear overheated or fouled with carbon. It may be necessary to clean the ignition electrode using steel wool. Once the pilot appears to be properly set, reinstall it into the appliance making sure to properly tighten the pilot line connection.

If the pilot is removed from the main burner in the course of servicing the appliance, it is important to reinstall it so that there is no gap between the top surface of the pilot tube and the underside of the metal filter support screen. When properly set it will not be possible to slip a business card between the pilot burner and the support screen. Figure 25 shows the burner box assembly with the metal filter cover removed to expose pilot tube.

Figure 26: Pilot and Burner Box

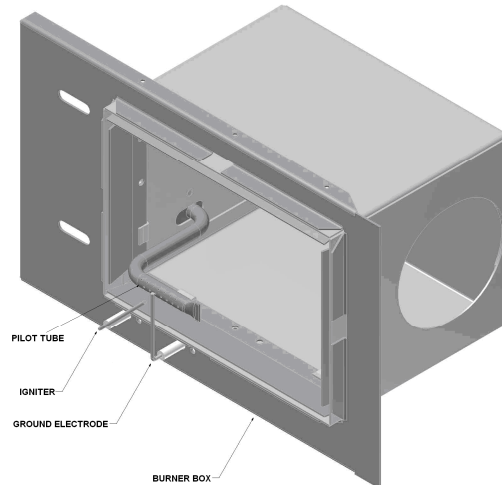

Once the spark is satisfactory, open the pilot gas and allow the pilot burner to light. Once air has been purged from the pilot line, the pilot flame should appear almost instantly at the initiation of spark. Cycle the pilot several times to confirm reliability. A properly set pilot will appear blue and will engulf the igniter and ground electrode.

Open the firing valve and allow the main burner to light. The pilot must not extinguish. After running for 15 minutes, cycle the appliance to ensure that the pilot remains stable.

20 OPERATION AND SERVICE

20.1 PRE-START CHECKLIST

Before operating the boiler, the entire system must be filled with water, purged of air and checked for leaks. Do not use Stop leak or other boiler compounds. The gas piping must also be leak tested.

Any safety devices including low water cutoff, flow switch and high limit used in with this boiler must receive periodic inspection (every six months) to assure proper operation. A low water cutoff of the float type should be flushed every six months. All relief valves should be inspected and manually operated every six months.

For your safety follow the lighting and operating instructions below and on the boiler.

To turn on main burner, slowly open firing valve after pilot is established.

Set primary system controller to desired temperature.

To turn off boiler close main manual gas valve, close pilot manual valve and turn off electric power to system.

20.2 START-UP

Gas appliances are rated based on sea level operation with no adjustment required at elevations up to 2000 ft. At elevations above 2000 ft the input rating must be reduced by 4% for each additional 1000 ft elevation. Never increase the input of the appliance above that for which it is rated.

Pilot Pressure Setting

The pilot was preset at the factory. The following description is for the benefit of the start-up technician should minor adjustment be required.

The pilot burner is controlled by a separate pilot valve. Pilot pressure setting is as shown in Table 9. A view port is provided on the appliance's return end to view the pilot and the main burners. If adjustment is necessary the following steps must be followed: Remove the lower front jacket panel; Remove the 1/8" plug from the elbow pressure tap and connect a manometer; Remove regulator adjustment screw cap from the pilot valve; Rotate the regulator adjustment screw clockwise to increase the manifold pressure or counterclockwise to decrease it; Once satisfied replace the regulator adjustment screw cap and the elbow pressure tap plug.

Table 11: Gas pressures at inlet to pilot

	PROPANE	NATURAL GAS
Minimum (inches W.C.)	3.9	1.3
Maximum (inches W.C.)	9.3	3.5

Pilot Flame Rectification Setting

The pilot flame rectification was preset at the factory. The following description is for the benefit of the start-up technician should minor adjustment be required. Set pilot to obtain best μA reading from flame rectification. Minimum average signal of 1.5 μA is required. If required, test the signal using a DC μA meter following this procedure for Honeywell S8600 ignition module: Disconnect ground wire at appliance transformer; Disconnect the 24V power and ground wires from all S8600 ignition modules not being tested; Set meter to μA DC: Connect one of the meter's terminals to the burner ground terminal on the S8600 and the other terminal to the burner ground wire; Pilot running without main burner will generate 1.5 μA average for best operation. With main burner running, the signal will be in a range of 4.0 to 7.0 μA .

High Fire Setting

The gas valve high fire pressure regulator is preset at the factory. The following description is for the benefit of the start-up technician should minor adjustment be required.

Optimum results are obtained when the appliance is operated with CO_2 readings as indicated in Table 12. If adjustment is necessary the following steps must be followed (please refer to Figure 26). In order to perform adjustments to the gas valve the MicoFlame must be firing before proceeding.

MF 60 – 150

To adjust the high fire setting

Set the Target Temperature to 190°F using the BTC 1 Controller.

Figure 27: Venturi & Gas Valve Assembly

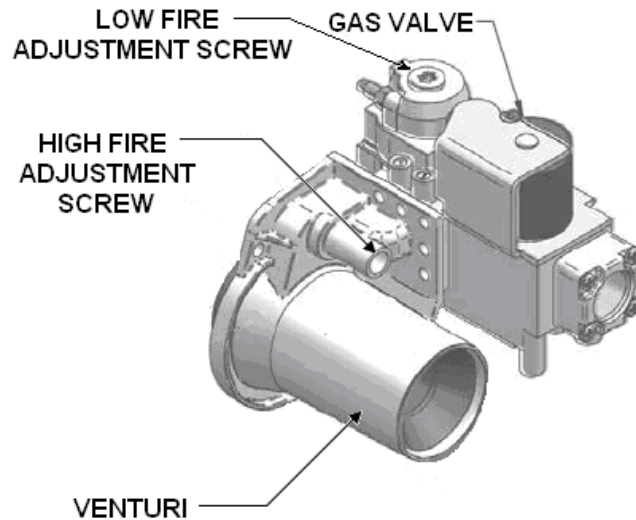

Once the appliance is at maximum fan speed locate the input adjustment screw on the side of the venturi. Using a flat head screwdriver turn the screw clockwise to decrease CO₂ levels and counter-clockwise to increase CO₂ levels. Turn the screw 1/4 turn in either way for each adjustment to keep track of the adjustments. After adjusting the screw wait a moment for the combustion levels to stabilize before attempting to make any further adjustments. Continue this procedure until combustion levels are satisfied.

Reset the Target Temperature to normal operating conditions on the BTC 1 Controller.

To adjust the low fire setting

Observe the Boiler Inlet Temperature. Set the Boiler Target temperature so that it is 10°F above the Boiler Inlet Temperature. The boiler will begin to modulate to low-fire as setpoint is being reached. The actual modulation rate will be shown on the screen as Modulation, this will be shown as a percentage. Low-fire is achieved at 25%.

When this is achieved locate the low fire adjustment screw as illustrated in Figure 26. This screw is covered with a cap, which can be removed using a Torx 40 screwdriver. With the screw cap removed using a Torx 40 screwdriver rotate clockwise to increase CO₂ levels and counter-clockwise to decrease CO₂ levels. When the correct combustion values are achieved replace the screw cap back on to the gas valve.

Reset the Target Temperature to normal operating conditions on the BTC 1 Controller.

MF 200 – 300

Figure 28: MF 200 – 300 Gas Valve

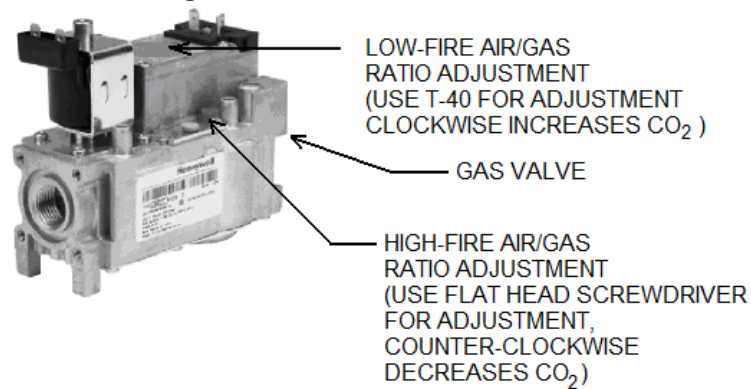

To adjust the high fire setting

Set the Target Temperature to 190°F using the BTC 1 Controller.

Once the appliance is at maximum fan speed locate the high-fire adjustment screw on the top side of the gas valve. The screw can be identified by a red cylinder casing around the screw. Using a thin flat head screwdriver turn the screw clockwise to decrease CO₂ levels and counter-clockwise to increase CO₂ levels. Turn the screw 1/4 turn in either way for each adjustment to keep track of the adjustments. After adjusting the screw wait a moment for the combustion levels to stabilize before attempting to make any further adjustments. Continue this procedure until combustion levels are satisfied.

Reset the Target Temperature to normal operating conditions on the BTC 1 Controller.

To adjust the low fire setting

Observe the Boiler Inlet Temperature. Set the Boiler Target temperature so that it is 10°F above the Boiler Inlet Temperature. The boiler will begin to modulate to low-fire as setpoint is being reached. The actual modulation rate will be shown on the screen as Modulation, this will be shown as a percentage. Low-fire is achieved at 25%.

When this is achieved locate the low fire adjustment screw as illustrated in Figure 27. Using a flat screwdriver rotate clockwise to increase CO₂ levels and counter-clockwise to decrease CO₂ levels. When the correct combustion values are achieved replace the screw cap back on to the gas valve.

Reset the Target Temperature to normal operating conditions on the BTC 1 Controller.

MF 400 – 600

Figure 29: MF 400 – 600 Gas Valve

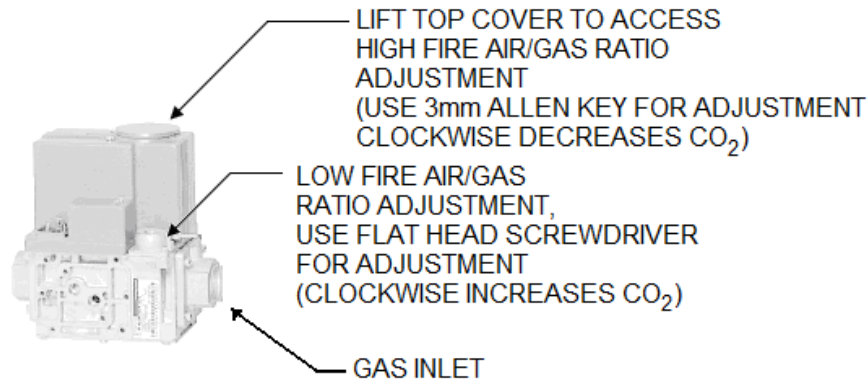

To adjust the high fire setting

Set the Target Temperature to 190°F using the BTC 1 Controller.

Once the appliance is at maximum fan speed locate the input adjustment screw on the top side of the gas valve. Using a flat head screwdriver turn the screw clockwise to decrease CO₂ levels and counter-clockwise to increase CO₂ levels. Turn the screw 1/4 turn in either way for each adjustment to keep track of the adjustments. After adjusting the screw wait a moment for the combustion levels to stabilize before attempting to make any further adjustments. Continue this procedure until combustion levels are satisfied.

Reset the Target Temperature to normal operating conditions on the BTC 1 Controller.

To adjust the low fire setting

Observe the Boiler Inlet Temperature. Set the Boiler Target temperature so that it is 10°F above the Boiler Inlet Temperature. The boiler will begin to modulate to low-fire as setpoint is being reached. The actual modulation rate can be shown on the screen as Modulation, this will be shown as a percentage. Low-fire is achieved at 25%.

The MicoFlame will respond immediately and operate at low fire. When this is achieved locate the low fire adjustment screw as illustrated in Figure 28. Using a flat screwdriver rotate clockwise to increase CO₂ levels and counter-clockwise to decrease CO₂ levels. When the correct combustion values are achieved replace the screw cap back on to the gas valve.

Reset the Target Temperature to normal operating conditions on the BTC 1 Controller.

Table 12: Combustion Values

		Natural Gas		Propane	
		CO ₂	CO	CO ₂	CO
Non-Condensing	Max. Fire	7.5% - 8.5%	< 50 PPM	9.0% - 10.0%	< 50 PPM
	Min. Fire	7.0% - 7.5%	< 50 PPM	8.5% - 9.0%	< 50 PPM
Condensing	Max. Fire	8.5% - 9.0%	< 50 PPM	10.0% - 10.5%	< 50 PPM
	Min. Fire	7.5% - 8.0%	< 50 PPM	9.0% - 9.5%	< 50 PPM

Blocked Flue Switch

The normally-closed blocked flue switch has been preset at the factory according to Table 9. In cases where the heater loses the flame signal as it approaches high-fire adjustment to the blocked flue switch may be necessary. The following description is for the benefit of the start-up technician should minor adjustment be required.

- 1) Remove the lower front jacket panel
- 2) Reduce sensitivity of blocked flue switch by turning the flat screw $\frac{1}{4}$ turn clockwise.
- 3) Observe the operation of the burner as it approaches high fire with the fan inlet $\frac{1}{3}$ blocked, if the heater continues to operate at high fire the switch has been correctly set. If not, repeat steps 2 and 3.
- 4) Re-install lower front jacket panel

Differential Air Switch

A differential air pressure switch is provided to prove air flow at minimum fire conditions

- 1) Remove the lower front jacket panel
- 2) Insert allen key into the switch located on the combustion chamber door
- 3) Reduce sensitivity of differential air switch by turning the hex screw $\frac{1}{4}$ turn counter-clockwise.
- 4) Re-install lower front jacket panel

Ignition System Safety Shut-Off Device

After initial fill while the main burner is firing, shut off gas to the pilot and clock the time taken for the main gas valve to shut down. If the safety control is functioning properly, power to the gas valve will be shut off within 4 seconds of the pilot gas being shut off. If shut down takes longer, ignition control or gas valve may be defective. If shutdown does not occur it is possible that the main gas flow is generating a signal at the pilot in which case the pilot shall not recycle with the pilot gas off.

20.3 SERVICE

Disconnect main power and turn off gas supply before servicing unit.

To remove and clean the burner, follow the detailed procedure in section 16 of this manual

After the first season of operation inspect the heat exchanger and venting. Follow the detailed instructions in section 6 of this manual.

CAUTION: Label all wires prior to disconnection when servicing controls. Wiring errors can cause improper and dangerous operation. Verify proper operation after servicing.

Any audible sounds in the equipment, like pinging, crackling or hissing are indications of scaling or lack of sufficient water flow. Under these conditions the boiler must be shut down immediately and the heat exchanger checked for damage. If the exchanger is damaged from scaling, it is not covered by warranty.

Should your equipment be subjected to fire, flood or some other unusual condition, turn off all gas and electrical supply. If you are unable to turn off the gas, call your gas company or gas supplier at once. Do not put the unit back in operation until it has been checked by a qualified agency to ensure that all controls are functioning properly.

Units that are not operated for a period of 60 days or more are considered seasonal operations. It is recommended that before returning one of these units to service, the proper operation of all controls be checked by a qualified service technician.

21 LIGHTING INSTRUCTIONS

- 1) Turn off electric power to boiler.
- 2) Close main manual valve and main firing valve and wait 5 minutes.
- 3) Set primary system controller to desired temperature.
- 4) Open pilot valve.
- 5) Turn on electric power to boiler. The electrode at the pilot should begin to spark after pre-purge is complete. The pilot valve will open to permit gas flow to the pilot.
- 6) There is a 15 second trial for ignition, which is enough time to light the pilot if air is not present in the pilot line. If pilot fails to light and you suspect air in the line, close the main manual valve and repeat lighting steps 1 thru 5.
- 7) Once the pilot lights, it should envelope the ignition rod and ground electrode. The pilot can be adjusted by removing the pilot regulator cover and turning the adjustment screw counter-clockwise to decrease it or clockwise to increase it.
- 8) Open the main manual and main firing valves to allow gas to reach the main burner. If the main burner fails to ignite, turn the firing valve off and check to see that the pilot is burning. If not, repeat lighting procedure steps 1 thru 7.

TO TURN OFF BOILER: Close main manual valve and main firing valve and turn off electric power to system.

22 TROUBLESHOOTING GUIDE

SYMPTOM	SOLUTION
1. Power light is not lit when switch is flipped to "ON"	<ul style="list-style-type: none"> • Check wiring to switch. • Check circuit breaker. • Check fuse.
2. Water flow light remains off.	<ul style="list-style-type: none"> • Verify that pump is running. • Check wiring to flow switch.
3. Pilot sparks but does not light	<ul style="list-style-type: none"> • Verify that main manual valve is open. • Follow lighting instructions to bleed air out of pilot line. • Remove main burner and inspect for moisture or dirt in pilot or in pilot line. • Verify that pilot is sealed to main burner base. • Verify that gas connections are tight.
4. Pilot lights momentarily, goes out and then sparks again repeatedly	<ul style="list-style-type: none"> • Observe pilot for proper flame. Adjust if necessary. • Check pilot flame signal. Properly set pilot to generate 1.5 μA. D.C. on average. • Remove main burner and ensure that the igniter and ground electrodes are positioned properly. Clean with steel wool if necessary. • Verify that back of burner box is fully engaged into the retaining slot in the combustion chamber base.
5. Pilot lights but main burner does not fire.	<ul style="list-style-type: none"> • Verify that high limit is set high enough to prevent short cycling. • Check pilot flame signal (μA). • Adjust pilot pressure for steady flame • Remove main burner. Check position of the igniter and ground electrode. Clean with steel wool if necessary.
6. Main burner lights but cycles off after a few minutes	<ul style="list-style-type: none"> • Verify that high limit is set high enough to prevent short cycling. • Adjust pilot pressure for steady flame • Remove main burner. Adjust pilot shield and clean ignition sensor.
7. Boiler starts to whine as the temperature rise increases.	<ul style="list-style-type: none"> • Verify that all air is bled from system. • Verify that the static pressure in cold system is at least 15 psig. • Check temperature rise across boiler to ensure adequate water flow. • If necessary, increase static water pressure and decrease gas pressure.

23 TYPICAL GAS TRAIN

Figure 30: MicoFlame Modulation 60 – 300 Gas Train

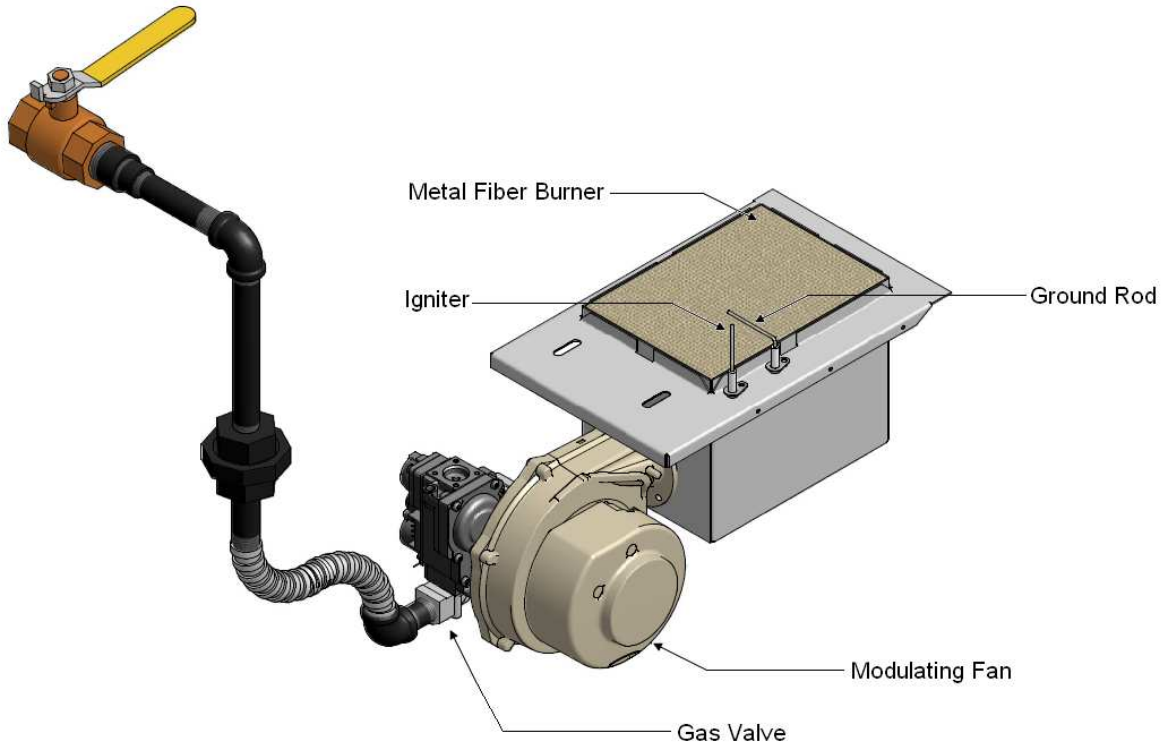
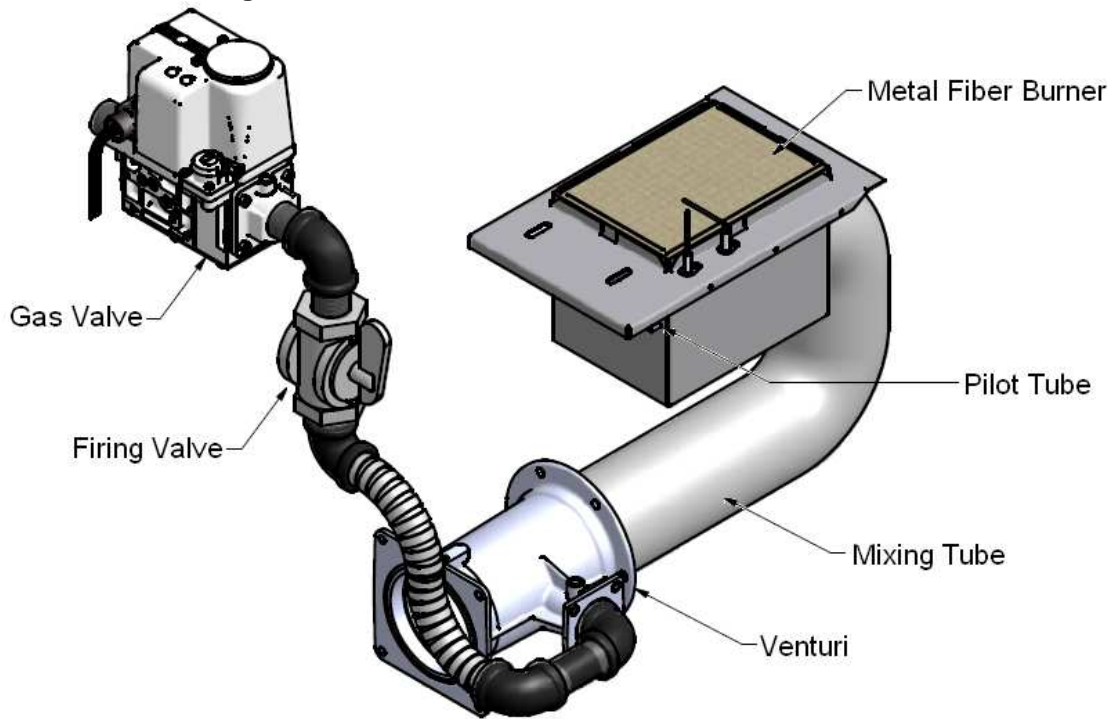

Figure 31: MicoFlame Modulation 400 – 600 Gas Train



24 ELECTRICAL DIAGRAMS

Each MicoFlame boiler will be provided with its own wiring diagram to guarantee that any options ordered with the unit are properly detailed.

The following diagrams 99-5085-C, 99-5086-C and 99-5086-S are provided as a typical sample only.

24.1 MF 60 - 300 INTERNAL WIRING CONNECTION DIAGRAM

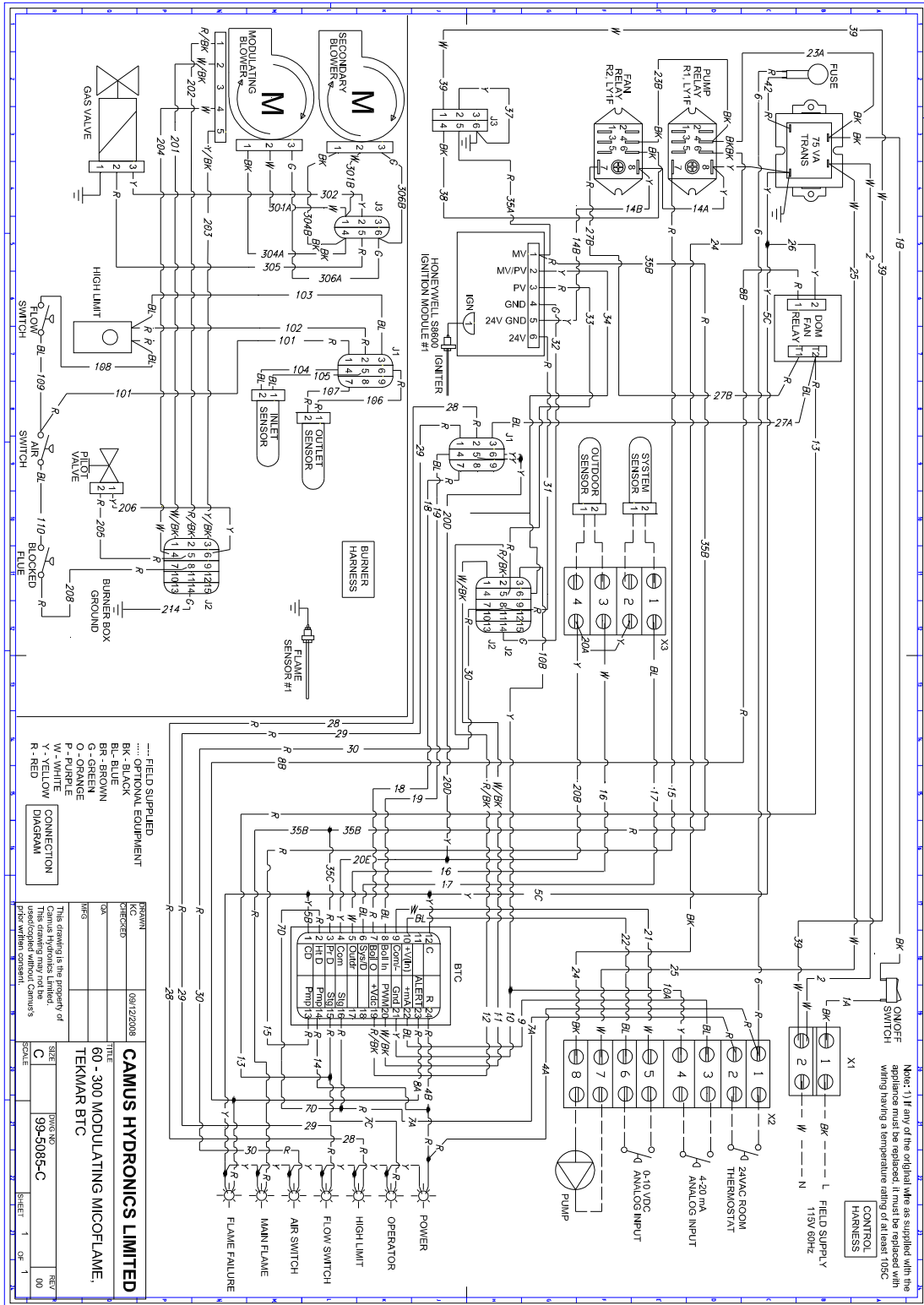

24.2 MF 400 - 600 INTERNAL WIRING CONNECTION DIAGRAM

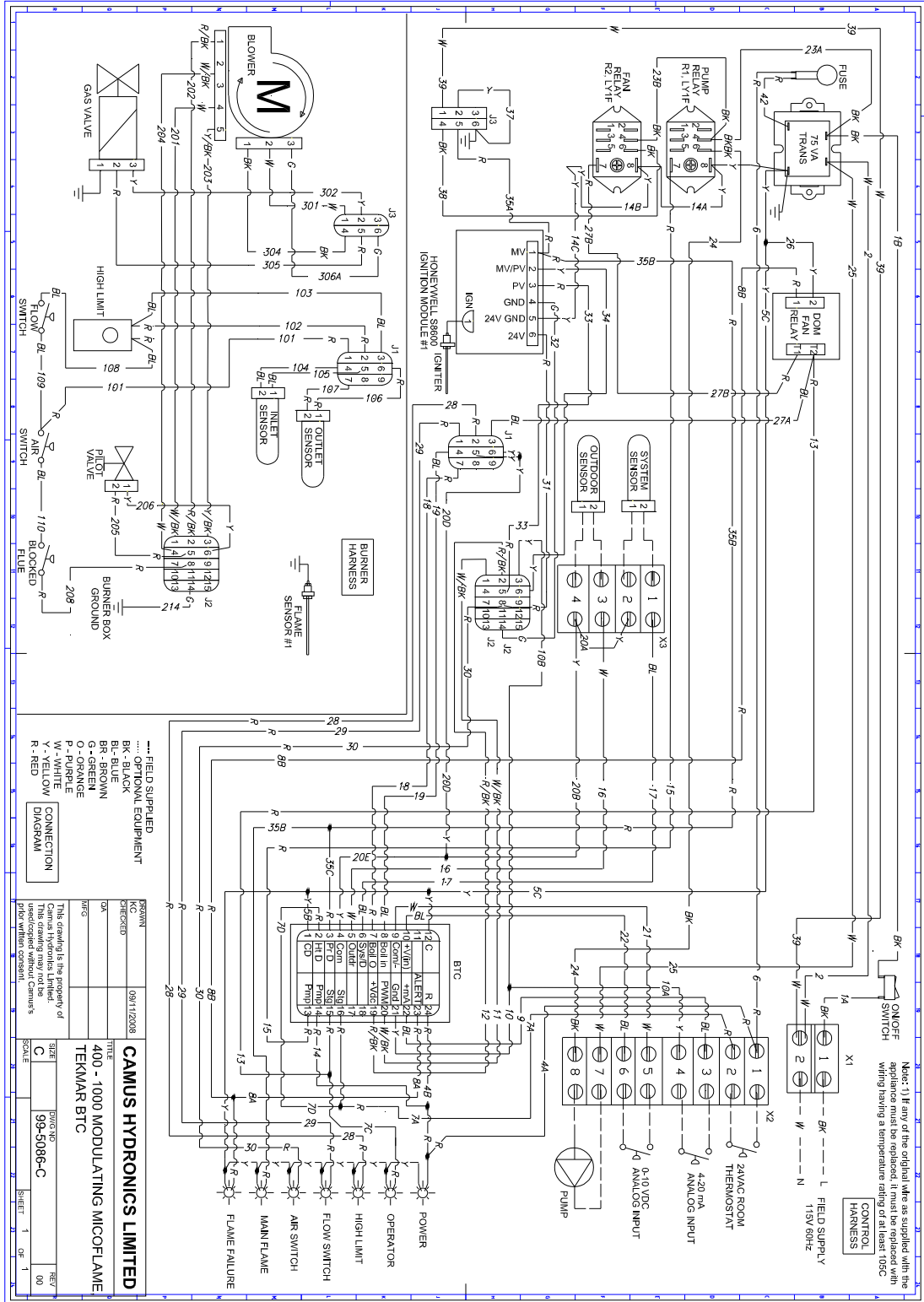

24.3 MF 60 – 1000 INTERNAL WIRING LADDER DIAGRAM

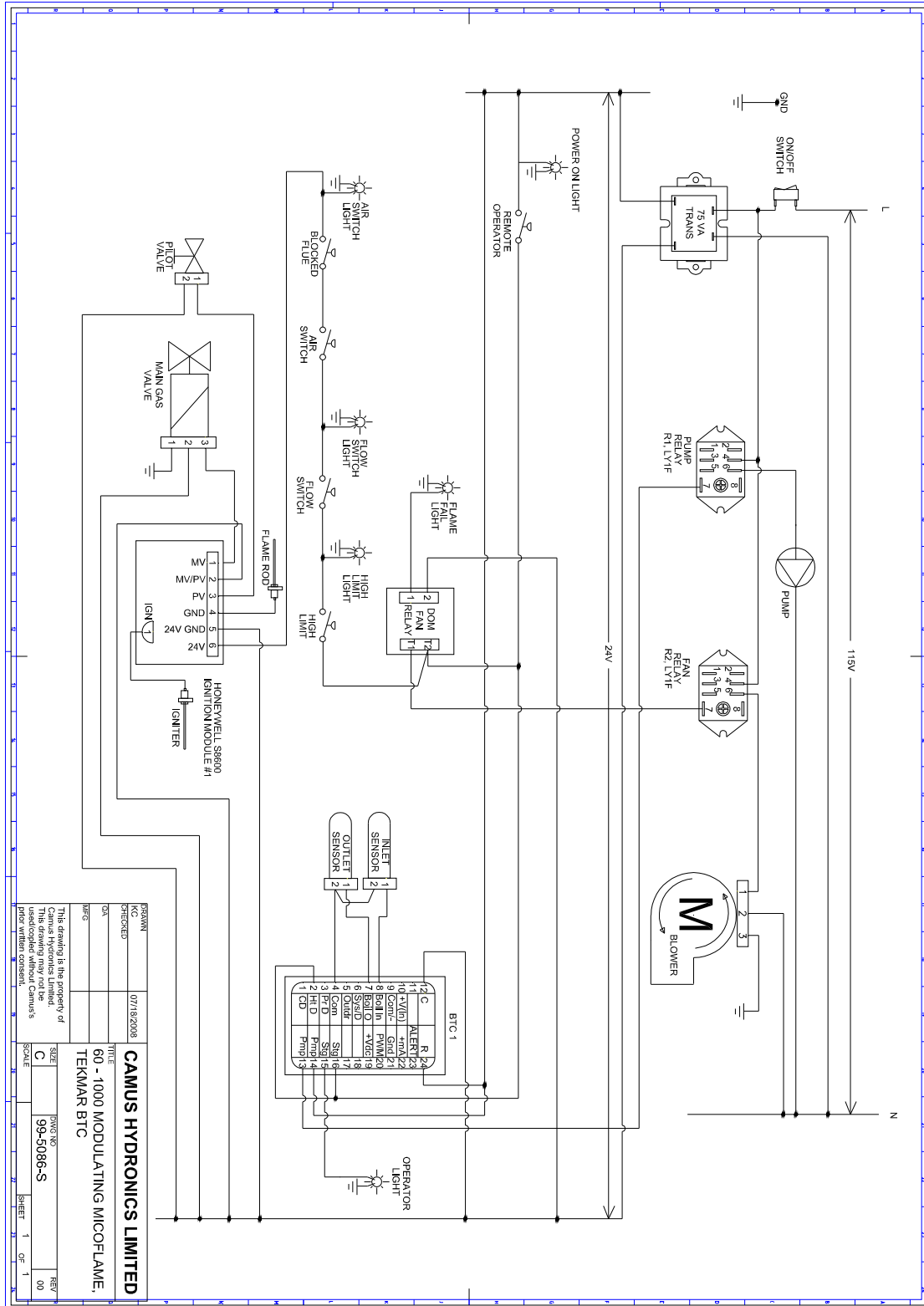

DESIGN	07/18/2008	CAMUS HYDRONICS LIMITED
REVISION		60 - 1000 MODULATING MICROFLAME,
DATE		TEKMAR BTC
BY		
CHKD		
APP'D		
SCALE	C	100% N.P.
SHEET	1	OF 1
REV	00	

This drawing is the property of Camus Hydronics Limited. It is to be used only for the project specified without Camus's prior written consent.

25 EXPLODED VIEW

MicoFlame
Exploded View

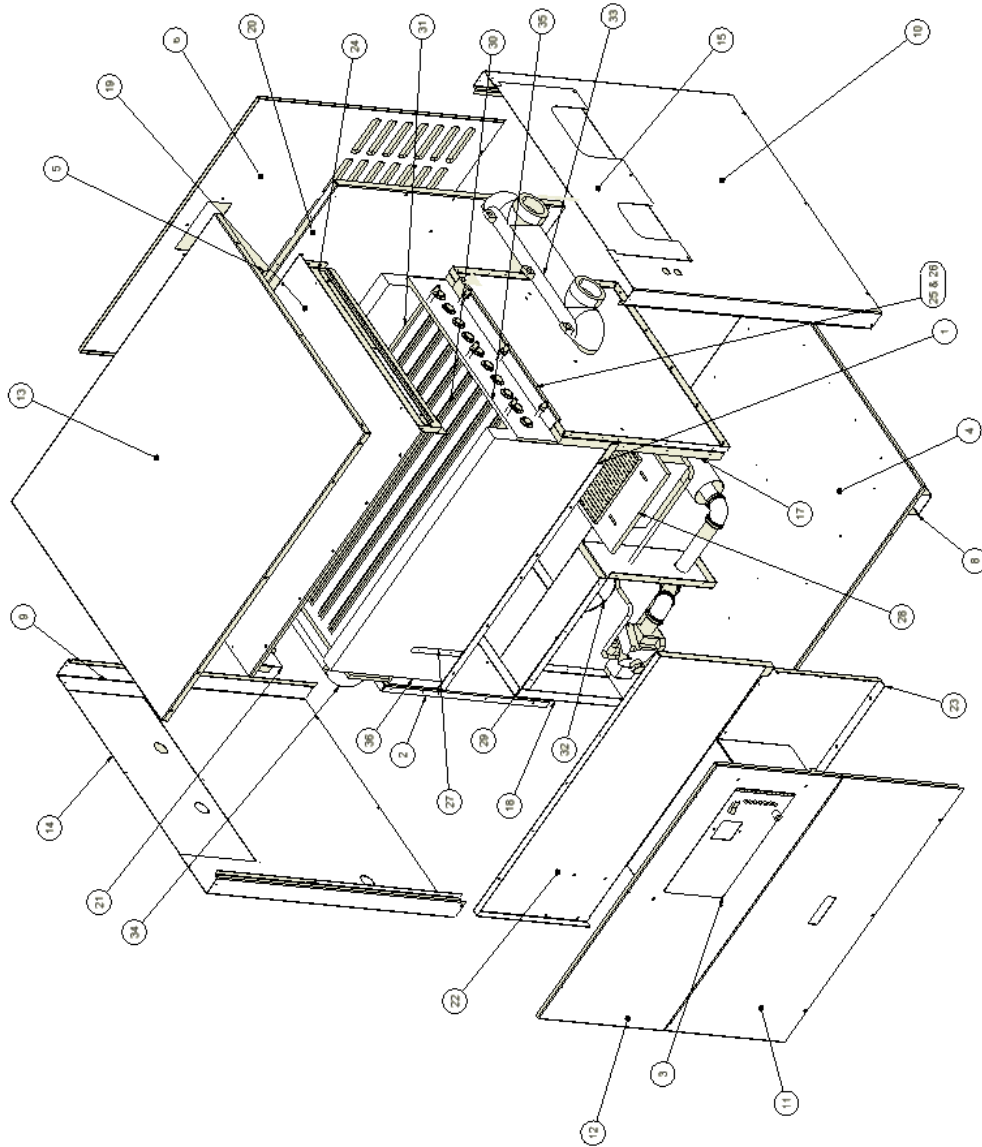

26 MICROFLAME REPLACEMENT PARTS LIST

Ref #	Part Name	MicoFlame Series Model								
		60	100	150	200	250	300	400	500	600
1	Combustion Chamber Base Panel	14-4075	14-4075	14-4075	14-4075	14-4055	14-4055	14-4005-01	14-4005-01	14-4005-03
2A	Combustion Chamber Common End Panel, Left	14-4050	14-4050	14-4050	14-4050	14-4050	14-4050	14-4000	14-4000	14-4000
2B	Combustion Chamber Common End Panel, Right	14-4051	14-4051	14-4051	14-4051	14-4051	14-4051	14-4001	14-4001	14-4001
3	Control Box Assembly	14-4028	14-4028	14-4028	14-4028	14-4028	14-4028	14-4028	14-4028	14-4028
4	Base Panel	14-4059-01	14-4059-01	14-4059-01	14-4059-01	14-4059-05	14-4059-05	14-4009-02	14-4009-02	14-4009-03
5	Flue Collector Outlet	14-4070 2 Req'd Per Unit						14-4020 2 Req'd Per Unit		
6	Outer Back (Non-Condensing)	14-4061-01	14-4061-01	14-4061-01	14-4061-01	14-4061-05	14-4061-05	14-4011-01	14-4011-01	14-4011-03
7	Header Bar Seal	14-4022-01	14-4022-01	14-4022-01	14-4022-01	14-4022-01	14-4022-01	14-4022-02	14-4022-02	14-4022-02
8	Leg	14-4014 2 Req'd Per Unit								
9	Outer Jacket Left	14-4082	14-4082	14-4082	14-4082	14-4082	14-4082	14-4032	14-4032	14-4032
10	Outer Jacket Right	14-4081	14-4081	14-4081	14-4081	14-4081	14-4081	14-4031	14-4031	14-4031
11	Outer Front Lower	14-4062-01	14-4062-01	14-4062-01	14-4062-01	14-4062-05	14-4062-06	14-4012-01	14-4012-02	14-4011-03
12	Outer Front Upper	14-4063-01	14-4063-01	14-4063-01	14-4063-01	14-4063-05	14-4063-06	14-4013-02	14-4013-02	14-4013-03
13	Top Cover	14-4060-01	14-4060-01	14-4060-01	14-4060-01	14-4060-05	14-4060-05	14-4010-01	14-4010-01	14-4010-03
14	Return Side Access Panel	14-4067	14-4067	14-4067	14-4067	14-4067	14-4067	14-4017	14-4017	14-4017
15	Inlet-Outlet Access Panel	14-4066	14-4066	14-4066	14-4066	14-4066	14-4066	14-4016	14-4016	14-4016
16	Stiffeners	N/A	N/A	N/A	N/A	N/A	N/A	14-4015-01	14-4015-01	14-4015-02
17	Combustion Chamber Support Right	14-4053	14-4053	14-4053	14-4053	14-4053	14-4053	14-4003	14-4003	14-4003
18	Combustion Chamber Support Left	14-4054	14-4054	14-4054	14-4054	14-4054	14-4054	14-4004-02	14-4004-02	14-4004-02
19	Flue Collector Top	14-4057-01	14-4057-01	14-4057-01	14-4057-04	14-4057-05	14-4057-06	14-4007-01	14-4007-01	14-4007-03

Ref #	Part Name	MicoFlame Series Model								
		60	100	150	200	250	300	400	500	600
20	Combustion Chamber Rear Panel	14-4072	14-4072	14-4072	14-4072	14-4052	14-4052	14-4002-01	14-4002-01	14-4002-01
21	Flue Collector End Bracket	14-4058 2 Req'd Per Unit						14-4008	14-4008	14-4008
22	Combustion Chamber Upper Front Panel	14-4076	14-4076	14-4076	14-4076	14-4056	14-4056	14-4006-01	14-4006-01	14-4006-03
23	Burner Drawer Door	14-4080-01	14-4080-01	14-4080-01	14-4080-01	14-4080-05	14-4080-05	14-4040	14-4040	14-4040
24	HX Header Bar Stop	14-4038-01	14-4038-01	14-4038-01	14-4038-01	14-4038-01	14-4038-01	14-4038-02	14-4038-02	14-4038-02
25	Heat Exchanger Support Brkt	14-4035-01	14-4035-01	14-4035-01	14-4035-01	14-4035-01	14-4035-01	14-4035-02	14-4035-02	14-4035-02
26	Heat Exchanger Support Brkt Stop	14-4036-01	14-4036-01	14-4036-01	14-4036-01	14-4036-01	14-4036-01	14-4036-02	14-4036-02	14-4036-02
27	HX Support - Left	14-4071	14-4071	14-4071	N/A	14-4071	N/A	14-4023	14-4023	N/A
28	Burner Box Assembly	14-4079	14-4079	14-4079	14-4079	14-4079	14-4079	14-4029	14-4029	14-4029
29	Fan Mounting Support (Staging)	N/A	N/A	N/A	N/A	N/A	N/A	14-4039-01	14-4039-01	14-4039-03
	Fan Mounting Support (Modulation)	N/A	N/A	N/A	N/A	N/A	N/A	14-4179	14-4179	14-4179
30	HX V Baffles	14-4041-01	14-4041-02	14-4041-03	14-4041-04	14-4041-05	14-4041-06	14-4041-07	14-4041-08	14-4041-09
31	HX Front & Rear Baffles	14-4042-01	14-4042-02	14-4042-03	14-4042-04	14-4042-05	14-4042-06	14-4042-07	14-4042-08	14-4042-09
32	Blower Assembly	55-0008	55-0008	55-0008	55-0008	55-0008	55-0008	55-0008	55-0008	55-0008
33	Inlet / Outlet Header	13-0110	13-0110	13-0110	13-0110	13-0110	13-0110	13-0110	13-0110	13-0110
34	Return Header	13-0111	13-0111	13-0111	13-0111	13-0111	13-0111	13-0111	13-0111	13-0111
35	Header Bar	14-4156	14-4156	14-4156	14-4156	14-4156	14-4156	14-4156	14-4156	14-4156
37	Gas Valve	VK8115 V1036	VK8115 V1036	VK8115 V1036	VK8115 V1036	VK8115 V1036	VR8615 B1044	V8730C 1015	V8730C 1015	V8730C 1023
38	Modulating Fan	55667.12210	55667.12210	55667.21120	55667.01970	55667.21080	55667.21200	55667.21200	55667.14002	55667.14002

Ref #	Part Name	MicoFlame Series Model								
		60	100	150	200	250	300	400	500	600
39	MicoFlame Modulating harness-1 burner	77-0018	77-0018	77-0018	77-0018	77-0018	77-0018	77-0018	77-0018	77-0018
40	Mico Modulating harness-Panel main (110V)	77-0019	77-0019	77-0019	77-0019	77-0019	77-0019	77-0019	77-0019	77-0019
41	Air Inlet Hole Cover	14-4083	14-4083	14-4083	14-4083	14-4083	14-4083	14-4083	14-4083	14-4083
42	Flue Collar	14-4068	14-4068	14-4068	14-4068	14-4068	14-4068	14-4018	14-4018	14-4018
43	Outer Jacket Economizer Cover	14-4090	14-4090	14-4090	14-4090	14-4090	14-4090	14-4046	14-4046	14-4046

* Condensing Models Only

 Not Shown in Exploded View

WARRANTY

GENERAL

Camus Hydronics Limited ("Camus"), extends the following LIMITED WARRANTY to the owner of this appliance, provided that the product has been installed and operated in accordance with the Installation Manual provided with the equipment. Camus will furnish a replacement for, or at Camus option repair, any part that within the period specified below, shall fail in normal use and service at its original installation location due to any defect in workmanship, material or design. The repaired or replacement part will be warranted for only the unexpired portion of the original warranty. This warranty does not cover failures or malfunctions resulting from: (1) Failure to properly install, operate or maintain the equipment in accordance with Camus' manual; (2) Abuse, alteration, accident, fire, flood, foundation problems and the like; (3) Sediment or lime buildup, freezing, or other conditions causing inadequate water circulation; (4) Pitting and erosion caused by high water velocity; (5) Failure of connected systems devices, such as pump or controller; (6) Use of non-factory authorized accessories or other components in conjunction with the system; (7) failing to eliminate air from, or replenish water in, the connected water system; (8) Chemical contamination of combustion air or use of chemical additives to water.

HEAT EXCHANGER

If within TEN years after initial installation of the appliance, a heat exchanger shall prove upon examination by Camus to be defective in material or workmanship, Camus will exchange or repair such part or portion on the following pro rated limited warranty. (1) Years one through five - standard warranty (2) Years six through ten - replacement purchase price pro rated at the following schedule: Year six - 60%, Year seven - 65%, Year eight -70%, Year nine - 75% Year ten -80% of the current list price of the current list price This term is reduced to FIVE years if the appliance is used for other than hydronic space heating.

Heat Exchanger shall be warranted for (20) years from date of installation against "Thermal Shock" (excluded, however, if caused by appliance operation at large changes exceeding 150 °F between the water temperature at intake and appliance temperature, or operating at appliance temperatures exceeding 230 °F).

BURNER

If within FIVE years after initial installation of the appliance a burner shall prove upon examination by Camus to be defective in material or workmanship, Camus will exchange or repair such part or portion.

ANY OTHER PART

If any other part fails within one (1) year after installation, or eighteen (18) months from date of factory shipment based on Camus' records, whichever comes first. Camus will furnish a replacement or repair that part. Replacement parts will be shipped f.o.b. our factory.

HOW TO MAKE A CLAIM

Any claim under this warranty shall be made directly to Camus Hydronics Limited Canadian Head Office

SERVICE LABOR RESPONSIBILITY

Camus shall not be responsible for any labour expenses to service, repair or replace the components supplied. Such costs are the responsibility of the owner.

DISCLAIMERS

Camus shall not be responsible for any water damage. Provisions should be made that in the event of a water/appliance or fitting leak, the resulting flow of water will not cause damage to its surroundings.

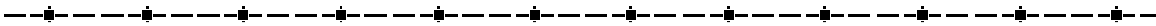

Name of Owner _____ Name of Dealer _____

Address _____ Address _____

Model No. _____ Serial No. _____

Date of Installation: _____ Date of Initial Operation: _____

6226 Netherhart Road, Mississauga, Ontario, L5T 1B7, CANADA

CAMUS Hydronics is a manufacturer of replacement parts for most copper finned water heaters and heating boilers as well as a



The CAMUS CERTIFIED! Seal assures you that Reliability, Efficiency & serviceability are built into every single unit! For more information

supplier of specialty HVAC products. Our service line is open 24 hours, 7 days a week!

on our innovative products from CAMUS Hydronics Limited, call 905-696-7800 today.



CAMUS HYDRONICS LTD.
6226 Netherhart Road, Mississauga, Ontario L5T 1B7
TEL: 905-696-7800 FAX: 905-696-8801